



# 2018 PRODUCT CATALOG



**marathon**<sup>®</sup>  
Special Products

**1931**  
SINCE

Since 1931, Marathon<sup>®</sup> Special Products have served the electrical/electronic component industry and have consistently met and/or exceeded customer quality requirements and expectations. Our facility in Bowling Green, Ohio, USA, contains all engineering and warehousing operations, as well as most manufacturing and testing operations. Our ability to mold, stamp and assemble all of our parts makes us unique in the industry. Marathon products include power blocks, terminal blocks, fuse holders and custom products.

For more than 85 years, we have developed a reputation as an industry leader in innovation and quality. Our team has a long history of providing first class service and responsiveness.





# MANUFACTURED IN THE USA





# WE CREATE A BETTER TOMORROW BY EFFICIENTLY CONVERTING POWER INTO MOTION

The whole world is on the move today. Everything from people and products to ideas and information. That means business has to be on the move, as well. We keep products – and businesses – moving forward, our products and solutions help make the world go.







## QUALITY

As an ISO 9001 registered company, our team is committed to achieving customer satisfaction by providing high quality products which meet or exceed customer needs and expectations.

## CUSTOMER TESTIMONIALS

- > *"One of the most reliable suppliers on my line card!"*



## INNOVATION

We will grow with new technologies that deliver real value for our customers.

## CUSTOMER TESTIMONIALS

- > *"They are a company striving for innovation rather than imitation."*

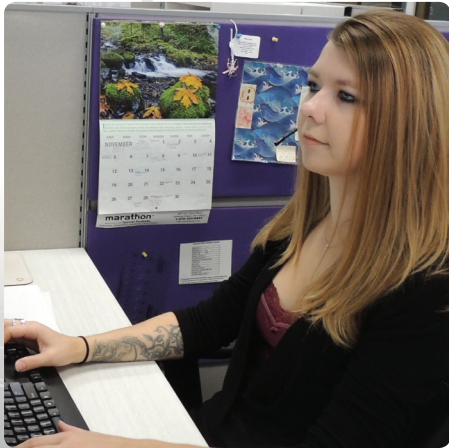

## CUSTOMER CARE

Our world class customer service team is committed to maintaining our status as an industry leader. With an average tenure of 20+ years, our reps know how to "Make it Easy for the Customer".

## CUSTOMER TESTIMONIALS

- > *"When you work with someone for over 30 years, you can form a special bond working together."*
- > *"Great customer service and customer focus."*
- > *"Level of service is tops! Keep doing what you do."*

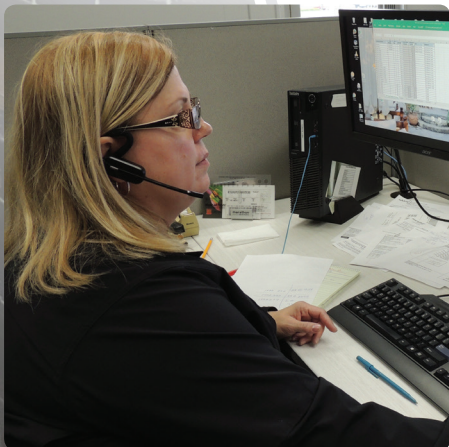



Developing **CUSTOM PRODUCTS** is what differentiates us from the rest of the industry. Our core value is to provide quality solutions to meet our customers' needs. We have the engineering and manufacturing capabilities to provide:

- Custom hardware configurations to terminal blocks
- Custom power block designs
- Custom fuse holder designs
- Custom terminal block designs for any application
- Custom ratings that aren't available

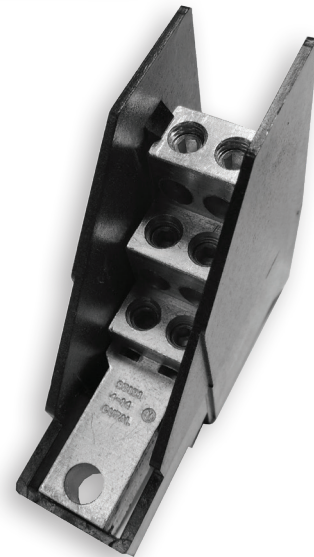
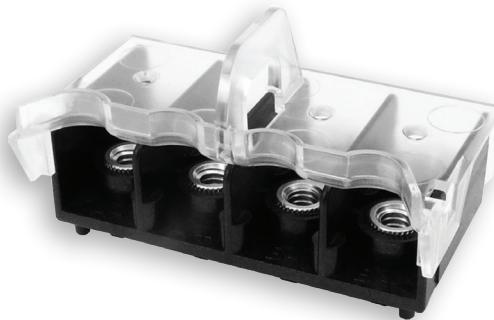
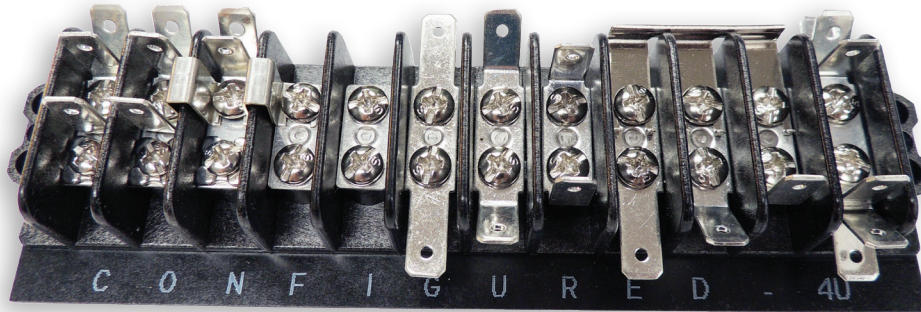

Our product development team can quickly respond to your requests with the use of 3D modeling, finite element analysis, rapid prototyping and a UL approved test lab to accelerate the performance verification process for any testing requirements.



# TABLE OF CONTENTS

General Info.....	1
<b>POWER BLOCKS</b>	
• Index & Descriptions.....	5
• Bulk Fastening.....	6
• Enclosed.....	7
• Splicer/Distribution.....	9
• High Voltage.....	15
• Stud Configurations.....	17
• Misc Configurations.....	20
• Covers.....	21
<b>TERMINAL BLOCKS</b>	
• Index & Descriptions.....	22
• Specialty Terminal Blocks	
› Studded Feed Thru.....	23
› Single Stud Connection.....	25
› Motor Blocks.....	26
› Grounding Lugs & Connectors.....	27
• Heavy Duty Terminal Blocks	
› Deadfront Type.....	28
› Barrier Type.....	30
• Barrier Terminal Blocks	
› Double Row & Accessories.....	31
› Single Row & Accessories.....	33
› Military Class.....	35
› Navy Class.....	36
• Sectional Terminal Blocks	
› DIN (Euro-Style).....	37
› NEMA® (Barrier).....	39
<b>FUSE HOLDERS</b>	
• Index & Descriptions.....	42
• Fuse Holders.....	45
• Accessories.....	55
Terms & Conditions.....	57
Warnings.....	59
Index.....	60

NEMA is a trademark of National Electrical Manufacturers Association. All Rights Reserved.



# GENERAL INFORMATION

## AGENCY APPROVALS:

The majority of products manufactured under the Marathon® Special Products brand are Underwriters Laboratories and Canadian Standards Association approved.

The approval status of products can be found throughout the catalog. Below are the different approval types and brief descriptions.

On February 1, 1994, the development and manufacturing of products under the Marathon Special Products brand name were registered to ISO standards. We are currently registered to ISO 9001:2008 quality standards.



Listed products by Underwriters Laboratories have been evaluated to U.S. safety requirements. These products are qualified for use in equipment without end-use agency approval when applied within the product's rated performance.



Listed products by Underwriters Laboratories have been evaluated to both U.S. and Canadian safety requirements. These products are qualified for use in equipment without end-use agency approval when applied within the product's rated performance.



Recognized products by Underwriters Laboratories have been evaluated to U.S. safety requirements. These products are components of a larger product or system and have guidelines addressing the suitability when used in an end product.



Recognized products by Underwriters Laboratories have been evaluated to U.S. and Canadian safety requirements. These products are components of a larger product or system and have guidelines addressing the suitability when used in an end product.



Certified by Canadian Standards Association, suitable for use in other equipment where Canadian Standards Association determines the suitability of the combination.



Compliance with European Union Low Voltage Directive.



# GENERAL INFORMATION

## TOLERANCES FOR CATALOG DIMENSIONS:













LENGTH DIMENSIONS	TOLERANCE	ALL OTHER DIMENSIONS	TOLERANCE
1.0" - 5.0"	± .030	X.X"	± .030
5.1" - 10.0"	± .050	X.XX"	± .020
10.1" - 15.0"	± .060	X.XXX"	± .010







Note: Catalog dimensions are for guidance only and are not to be construed as inspection standards.

This catalog is intended to present product data that will help the end user with design application. We reserve the right to change or update without notice.

### STRANDED WIRE SIZES AND AMPACITY FOR 75° C WIRE (COPPER)

Per UL Table 310.15 (B) (16)

													
SIZE	#14	#12	#10	#8	#6	#4	#3	#2	#1	1/0	2/0	3/0	4/0
DIAMETER	.073	.092	.115	.146	.184	.235	.281	.295	.335	.380	.420	.475	.530
AMPS	20	25	35	50	65	85	100	115	130	150	175	200	230

							
SIZE	250kcmil	300kcmil	350kcmil	400kcmil	500kcmil	600kcmil	750kcmil
DIAMETER	.580	.635	.690	.730	.820	.893	.998
AMPS	255	285	310	335	380	420	475

### SCCR INFORMATION:

The requirements of the National Electric Code (NEC) and UL 508A now require many electrical panels to carry a Short Circuit Current Rating (SCCR). Analyzing the SCCR of individual components and overcurrent protection devices is a method of determining the SCCR of an electrical assembly.

Many of our recognized and listed power blocks have now been tested and approved for higher SCCR. The higher ratings are based on proper wire sizes and the appropriate circuit protection device (fuses or circuit breakers). UL 508A does allow default SCCR for power distribution blocks of 10,000A with no additional testing.



# GENERAL INFORMATION

## FLEXIBLE STRANDED WIRE INFORMATION:

Traditionally, power blocks and fuse holders have been evaluated for use with rigid (Class B & C) wire only. The majority of our products have been evaluated for use with flexible stranded wire classes such as Class G, H, I (DLO) and K per UL 486A-B. This enables customers to be UL and NEC compliant while using flexible classes of wire without the use of crimp type terminals. We also supply a range of studded products to allow for the use of crimp terminals, which are recommended for larger wire sizes (greater than #1 AWG).

Flexible stranded wire classes differ in that they also bring additional considerations to address such as an increase in wire diameter and the number of strands per a given wire size. The photo to the right shows two 250 kcmil wires of different classes. The one on the left is the traditional Class B with 37 strands. The one on the right is a finely stranded Class K. Although they are the same wire classification of 250, you can see the Class K is larger in diameter. This illustrates the need to specify a terminal to accept a larger standard wire size. The table below shows the increase in strand count per each wire size.

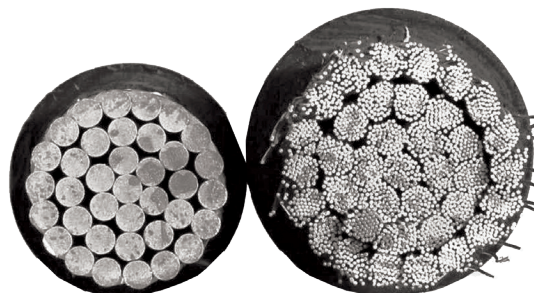

WIRE GAUGE AWG	AWG/KCMIL						
	RIGID STRANDED			FLEXIBLE STRANDED			
	CSA COMPACT	CLASS B	CLASS C	CLASS G	CLASS H	CLASS I (DLO)	CLASS K
	NUMBER OF STRANDS*						
#20	-	7	19	-	-	-	10
#18	-	7	19	-	-	-	16
#16	-	7	19	-	-	-	26
#14	-	7	19	-	-	19	41
#12	-	7	19	-	-	19	65
#10	-	7	19	-	-	27	104
#8	7	7	19	49	133	41	168
#6	7	7	19	49	133	63	266
#4	7	7	19	49	133	105	420
#2	7	7	19	49	133	161	665
#1	19	19	37	133	259	210	836
1/0	19	19	37	133	259	266	1064
2/0	19	19	37	133	259	342	1323
3/0	19	19	37	133	259	418	1666
4/0	19	19	37	133	259	532	2107
250 kcmil	37	37	61	259	427	637	2499
300 kcmil	37	37	61	259	427	735	2989
350 kcmil	37	37	61	259	427	882	3458
400 kcmil	37	37	61	259	427	980	3990
500 kcmil	37	37	61	259	427	1225	5054
600 kcmil	37	37	61	427	427	1470	6065
750 kcmil	37	61	61	427	427	1850	7581
1,000 kcmil	37	61	61	427	427	2527	10101

\*Specific quantity of strands may differ by manufacturer.

# GENERAL INFORMATION

## FEEDER & BRANCH CIRCUIT VOLTAGE REQUIREMENTS PER UL STANDARDS

### SPACING REQUIREMENTS PER APPLICATION TYPE

UL STANDARD <sup>(1)</sup> (UP TO 251-600V)	LINE TO LINE OR PARTS OF OPPOSITE		LIVE PART TO GROUND	PRODUCT TO SATISFY MINIMUM <sup>(2)</sup> REQUIREMENTS	COMPLIANT PRODUCT SERIES <sup>(3)</sup>
	THRU AIR	OVER SURFACE			
508A Feeder Circuits	1"	2"	1"	Listed Power Distribution Blocks	EPB, 134, 135
508A Branch Circuits	3/8"	1/2"	1/2"	Class B or C Recognized Terminal Blocks	141, 132, 133, 145
1995 HVAC Circuits <sup>(4)</sup>	3/8"	1/2"	1/2"	Class B or C Recognized Terminal Blocks	141, 132, 133, 145

<sup>(1)</sup> All cited standards and ratings should be verified to the current revision and full requirements.

<sup>(2)</sup> Listed power distribution blocks can be used in all applications as they exceed spacing requirements

- Recognized power terminal blocks may be suitable in a feeder circuit should they meet the spacing requirements at the application voltage level (see charts below)

<sup>(3)</sup> Primary series promoted - 142, 143 & 144 are still available

<sup>(4)</sup> UL 1995 control circuits used to start, stop, regulate or control the speed of a motor is to comply with the standard for industrial control equipment, UL 508 (per 3.10.3.1).

### UL 1953 SPACING REQUIREMENTS (MAX, IN INCHES) - LISTED "POWER DISTRIBUTION BLOCKS"

VOLTAGE	THROUGH AIR	OVER SURFACE
0-125	0.500	0.750
126-250	0.750	1.250
251-1000	1.000	2.000

### UL 1059 SPACING REQUIREMENTS (MAX, IN INCHES) - RECOGNIZED "TERMINAL BLOCKS"

CLASS*	VOLTAGE	THROUGH AIR	OVER SURFACE
A	51-150	0.500	0.750
	151-300	0.750	1.250
	301-600	1.000	2.000
B	51-150	0.063	0.063
	151-300	0.094	0.094
	301-600	0.375	0.500
C	51-150	0.125	0.250
	151-300	0.250	0.375
	301-600	0.375	0.500





Class A: Service, including deadfront switchboards, panel boards and service equipment

Class B: Commercial appliances including business equipment and electronic data processing equipment

Class C: Industrial, general

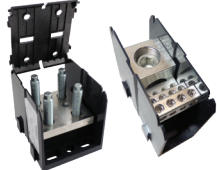
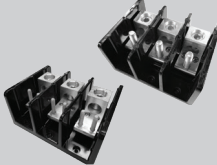

# POWER BLOCK TYPES

POWER BLOCK TYPE	PAGE #	DESCRIPTION	IMAGE
BULK FASTENING (BFPB)	6	The BFPB Series is a single pole design that consists of a series of stud fasteners to allow you to terminate various combinations of crimp lugs or flexible bus bar with one configuration. The series is ideal for use with flexible stranded wire terminations or large and abnormal wiring combinations.	
ENCLOSED (EPB)	7	The EPB Series are enclosed versions of our traditional power block configurations. This series consists of a modular single pole design that provides touch proof protection for splicer and distribution connector styles.	
SPLICER & DISTRIBUTION	9	Splicer and distribution power blocks are our traditional NEMA® style offering. Splicer power blocks provide the same number of wire inputs as outputs, and distribution power blocks provide multiple load outputs per each incoming wire.	
HIGH VOLTAGE (HVPB)	15	The HVPB series are high voltage (1500 AC/DC) versions of our traditional power block configurations. This series consists of a modular single pole design for splicer, distribution and studded connector styles.	
STUD CONFIGURATIONS	17	Studded power blocks are part of our traditional NEMA style offering. These power blocks provide studs, or a combination of bare wire terminals with the stud to terminate crimp lugs or bus bar to distribute power.	
MISCELLANEOUS CONFIGURATIONS	20	Miscellaneous power blocks are part of our traditional NEMA style offering. These power blocks provide tapped holes or quick-connects in addition to bare wire terminals to splice or distribute power.	

## STANDARDS:

Regal's Marathon® Special Products power blocks are either UL recognized or listed. Most have either CSA certification or cUR recognition for Canadian customers, as well as compliance to CE (Component IEC 60947-7-1).

**RECOGNIZED** power terminal blocks comply to UL 1059 and CSA C22.2 No. 158. All of our power blocks meet the 600V spacing requirements for application classes B & C and some Class A (135s): See General Information (pg 4) for class descriptions.

**LISTED** power distribution blocks comply to UL 1953. These are all rated 600V and are intended to be used on the load side of service equipment in accordance with the National Electrical Code, NFPA 70. Listed power blocks provide feeder circuit terminal spacing requirements of UL508A.

NEMA is a trademark of National Electrical Manufacturers Association. All Rights Reserved.

# BULK FASTENING

## ELECTRICAL:

1605 amps

1000 volts AC/DC (cULus)

High SCCRs:

- 100kA with fusing
- 35kA standard (no OCPD)

Flexible stranded wire compliant

Multiple wire ratings

## STANDARDS:

UL 1059 recognized file no. XCFR2.E62806

cUR recognized file no. XCFR8.E62806 (UL 1059)

RoHS compliant

## WEBSITE RESOURCES:

Detailed product data sheets

- Material information
- Termination & mounting specifications
- Detailed SCCR information

Dimensional drawings & 3D CAD files

Accessories available

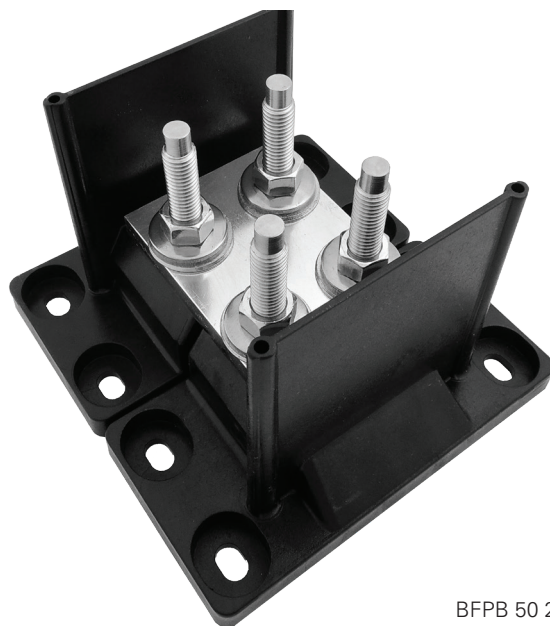

BFPB 50 2 2

CATALOG #	STUD POSITIONS	STUD SIZE	DIMENSIONS (INCHES)				COVER PART #
			PITCH	LENGTH	WIDTH	HEIGHT	
BFPB 50 2 2	2	1/2	2.125	7.14	6.89	4.99	CC BFPB 2 2
BFPB 50 2 3	3	1/2	2.125	9.27	6.89	4.99	CC BFPB 2 3
BFPB 50 2 4	4	1/2	2.125	11.39	6.89	4.99	CC BFPB 2 4
BFPB 50 2 5	5	1/2	2.125	13.52	6.89	4.99	CC BFPB 2 5
BFPB 50 2 6	6	1/2	2.125	15.64	6.89	4.99	CC BFPB 2 6
BFPB 37 1 3	3	3/8	1.625	8.27	6.89	4.99	CC BFPB 1 3
BFPB 37 1 4	4	3/8	1.625	9.89	6.89	4.99	CC BFPB 1 4
BFPB 37 1 5	5	3/8	1.625	11.52	6.89	4.99	CC BFPB 1 5
BFPB 37 1 6	6	3/8	1.625	13.14	6.89	4.99	CC BFPB 1 6

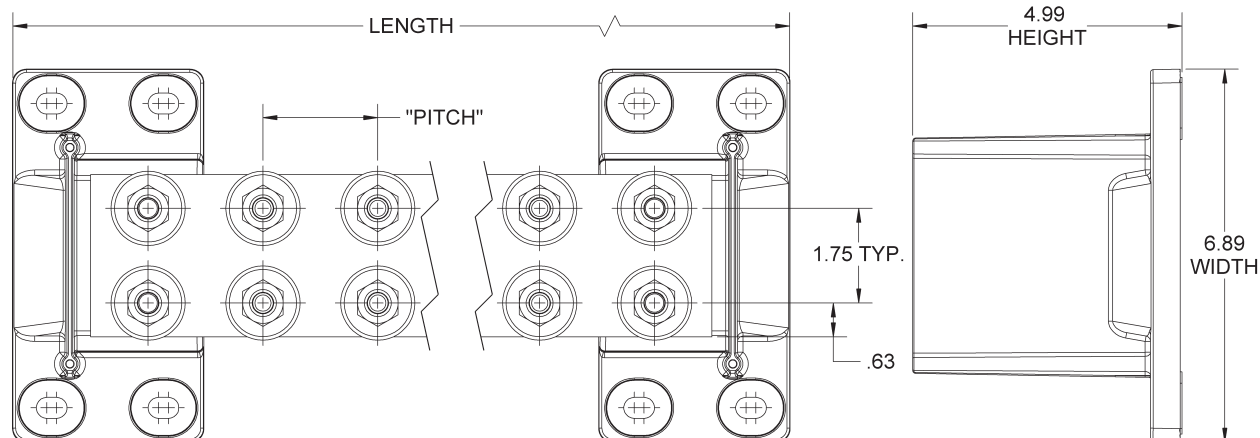



## ENCLOSED - SPLICER/DISTRIBUTION

### ELECTRICAL:

115 to 760 amps  
 600 volts AC/DC (UL)  
 High SCCRs (35 to 100kA) with fusing or circuit breakers  
 Flexible stranded wire compliant  
 Multiple wire ratings

### STANDARDS:

UL 1953 listed - or - UL 1059 recognized

- Listed file no. QPQS.E309401
- Recognized file no. XCFR2.E62806

CSA certified file no. LR19766 (CSA C22-2 No. 158)  
 CE (Component IEC 60947-7-1)  
 RoHS compliant (All)

### WEBSITE RESOURCES:













Detailed product data sheets

- Material information
- Termination & mounting specifications
- Multiple wire rating specifications
- Detailed SCCR information

Dimensional drawings & 3D CAD files  
 Accessories available







































EPBAP48

AMPS	CATALOG #	MOUNTING STYLE	MAX SCCR	CONNECTOR MATERIAL	LINE SIDE		LOAD SIDE		FEEDER CIRCUIT COMPLIANT PER UL508
					WIRE RANGE AWG/kcmil	CONNECTOR OPENINGS/POLE	WIRE RANGE AWG/kcmil	CONNECTOR OPENINGS/POLE	
115	EPBAD21	DIN/Panel	100,000	AL	#2 - #14	1 	#2 - #14	1 	Yes
115	EPBAD24	DIN/Panel	65,000	AL	#2 - #14	1 	#10 - #18	4 	Yes
200	EPBAD42	DIN	100,000	AL	3/0 - #14	1 	3/0 - #14	1 	Yes
200	EPBAP42	Panel	100,000	AL	3/0 - #14	1 	3/0 - #14	1 	Yes
200	EPBCD42	DIN	100,000	CU	3/0 - #14	1 	3/0 - #14	1 	Yes
200	EPBCP42	Panel	100,000	CU	3/0 - #14	1 	3/0 - #14	1 	Yes

# ENCLOSED - SPLICER/DISTRIBUTION

POWER BLOCKS

AMPS	CATALOG #	MOUNTING STYLE	MAX SCCR	CONNECTOR MATERIAL	LINE SIDE		LOAD SIDE		FEEDER CIRCUIT COMPLIANT PER UL508
					WIRE RANGE AWG/kcmil	CONNECTOR OPENINGS/ POLE	WIRE RANGE AWG/kcmil	CONNECTOR OPENINGS/ POLE	
200	EPBAD45	DIN	100,000	AL	3/0 - #14	1 	#2 - #14	4 	Yes
200	EPBAP45	Panel	100,000	AL	3/0 - #14	1 	#2 - #14	4 	Yes
200	EPBCD45	DIN	100,000	CU	3/0 - #14	1 	#2 - #14	4 	Yes
200	EPBCP45	Panel	100,000	CU	3/0 - #14	1 	#2 - #14	4 	Yes
200	EPBAP48	Panel	100,000	AL	3/0 - #14	1 	#6 - #14 #2 - #14	8 	Yes
200	EPBAD48	DIN	100,000	AL	3/0 - #14	1 	#6 - #14 #2 - #14	8 	Yes
335	EPBAD74	DIN	10,000	AL	400 - #6/ 2/0 - #14	1/1 	#2 - #14	8 	--
335	EPBAP74	Panel	100,000	AL	400 - #6/ 3/0 - #14	1/1 	#2 - #14	8 	--
335	EPBCD74	DIN	10,000	CU	400 - #6/ 3/0 - #14	1/1 	#2 - #14	8 	--
335	EPBCP74	Panel	100,000	CU	400 - #6/ 3/0 - #14	1/1 	#2 - #14	8 	--
510	EPBAD71	DIN	10,000	AL	250 - #6	2 	250 - #6	2 	--
510	EPBAP71	Panel	100,000	AL	250 - #6	2 	250 - #6	2 	--
510	EPBCD71	DIN	10,000	CU	250 - #6	2 	250 - #6	2 	--
510	EPBCP71	Panel	100,000	CU	250 - #6	2 	250 - #6	2 	--
760	EPBAP81	Panel	100,000	AL	500 - #4	2 	500 - #4	2 	Yes
760	EPBAP84	Panel	100,000	AL	500 - #4	2 	2/0 - #14	8 	Yes
760	EPBCP84	Panel	100,000	CU	500 - #4	2 	2/0 - #14	8 	Yes
760	EPBAP86	Panel	100,000	AL	500 - #4	2 	#4 - #14	12 	Yes



# SPLICER/DISTRIBUTION

## ELECTRICAL:

- 60 to 2280 amps
- 600 volts AC/DC (UL)
- High SCCRs (35 to 100kA) with fusing or circuit breakers
- Flexible stranded wire compliant
- Multiple wire ratings

## STANDARDS:

- UL 1953 listed - or - UL 1059 recognized
  - Listed file no. QPOS.E309401
  - Recognized file no. XCFR2.E62806
- CSA certified file no. LR19766 (CSA C22-2 No. 158)
- CE (Component IEC 60947-7-1)
- RoHS compliant (All)

## WEBSITE RESOURCES:

- Detailed product data sheets
  - Material information
  - Termination & mounting specifications
  - Multiple wire rating specifications
  - Detailed SCCR information
- Dimensional drawings & 3D CAD files
- Accessories available



1413400



1333595CH

## ORDERING CODE:

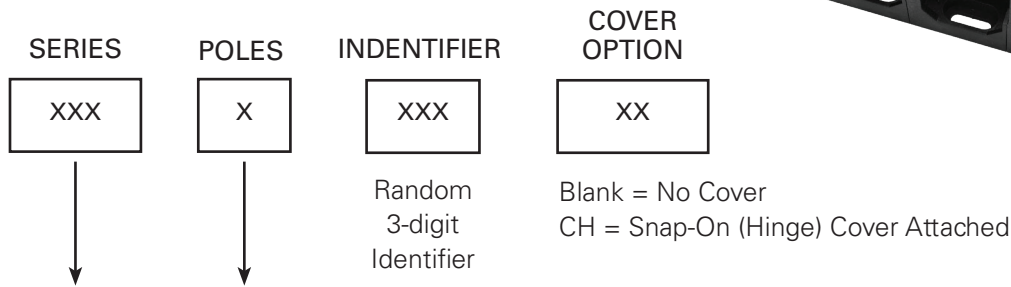





































SERIES	POLES (x)	DIMENSIONS (INCHES) 3-POLE			COVER TYPE AVAILABLE *
		WIDTH	LENGTH	HEIGHT	
132	0/1/2/3	2.54	3.00	2.42	SNAP-ON
133	1/2/3	5.36	4.00	3.33	SNAP-ON
134	3	5.64	5.00	3.92	SNAP-ON
135	1/2/3	10.08	5.73	4.77	SNAP-ON
140	2/3	5.38	2.90	2.06	SCREW-ON
141	1/2/3/4	2.12	2.29	1.62	SNAP-ON
142	1/2/3	2.75	2.88	1.78	SCREW-ON
143	1/2/3	5.00	4.00	2.61	SCREW-ON
144	1/2/3	6.03	4.75	2.91	SCREW-ON
145	1/2/3	8.54	5.5	3.13	SCREW-ON

\*Covers can be found on Page 21







































# SPLICER/DISTRIBUTION

POWER BLOCKS







































AMPS	CATALOG #	POLES (x)	MATERIAL		LINE SIDE		LOAD SIDE		FEEDER CIRCUIT COMPLIANT PER UL508
			INSULATOR	CONN.	WIRE RANGE AWG/kcmil	CONNECTOR OPENINGS/ POLE	WIRE RANGE AWG/kcmil	CONNECTOR OPENINGS/ POLE	
60	141x403	1/2/3/4	Thermo-Plastic	AL	#2 - #14	1 	#10 - #18	2 	--
115	141x300	1/2/3/4	Thermo-Plastic	AL	#2 - #14	1 	#2 - #14	1 	--
115	142x552	1/2/3	Phenolic	AL	#2 - #14	1 	#2 - #14	1 	--
115	141x400	1/2/3/4	Thermo-Plastic	AL	#2 - #14	1 	#10 - #18	4 	--
150	142x121	1/2/3	Phenolic	CU	1/0 - #14	1 	1/0 - #14	1 	--
175	132x572	0/1/2/3	Thermo-Plastic	AL	2/0 - #14	1 	2/0 - #14	1 	--
175	142x572	1/2/3	Phenolic	AL	2/0 - #14	1 	2/0 - #14	1 	--
175	132x972	1/2/3	Thermo-Plastic	CU	2/0 - #14	1 	2/0 - #14	1 	--
175	132x570	0/1/2/3	Thermo-Plastic	AL	2/0 - #14	1 	#4 - #14	4 	--
175	142x570	1/2/3	Phenolic	AL	2/0 - #14	1 	#4 - #14	4 	--
175	132x580	0/1/2/3	Thermo-Plastic	AL	2/0 - #14	1 	#4 - #14	6 	--
175	140x402	2/3	Phenolic	AL	2/0 - #14	1 	#4 - #14	4 	--
175	140x401	2/3	Phenolic	AL	2/0 - #14	1 	#4 - #14	6 	--
175	132x970	0/1/2/3	Thermo-Plastic	CU	2/0 - #14	1 	#4 - #14	4 	--
175	142x970	1/2/3	Phenolic	CU	2/0 - #14	1 	#4 - #14	4 	--
175	1343580	3	Thermo-Plastic	AL	2/0 - #14	1 	#4 - #14	6 	Yes
200	1343570	3	Thermo-Plastic	AL	3/0 - #14	1 	#2 - #14	4 	Yes
200	1343572	3	Thermo-Plastic	AL	3/0 - #14	1 	3/0 - #14	1 	Yes







































# SPLICER/DISTRIBUTION

AMPS	CATALOG #	POLES (x)	MATERIAL		LINE SIDE		LOAD SIDE		FEEDER CIRCUIT COMPLIANT PER UL 508
			INSULATOR	CONN.	WIRE RANGE AWG/kcmil	CONNECTOR OPENINGS/POLE	WIRE RANGE AWG/kcmil	CONNECTOR OPENINGS/POLE	
200	1343548	3	Thermo-Plastic	AL	3/0 - #14	1 	#6 - #14 #2 - #14	8 	Yes
255	143x123	1/2/3	Phenolic	AL	250 kcmil - #6	1 	250 kcmil - #6	1 	--
255	140x801	2/3	Phenolic	CU	250 - #6	1 	250 - #6	1 	--
310	140x303	2/3	Phenolic	AL	350 - #6	1 	350 - #6	1 	--
310	143x126	1/2/3	Phenolic	AL	350 - #6	1 	350 - #6	1 	--
310	133x126	1/2/3	Thermo-Plastic	AL	350 - #6	1 	350 - #6	1 	--
310	1343582	3	Thermo-Plastic	AL	350 - #6	1 	350 - #6	1 	Yes
310	140x404	2/3	Phenolic	AL	350 - #6	1 	#4 - #14	6 	--
310	133x554	1/2/3	Thermo-Plastic	AL	350 - #6	1 	2/0 - #14	2 	--
310	140x410	2/3	Phenolic	AL	350 - #6	1 	2/0 - #14	2 	--
310	143x554	1/2/3	Phenolic	AL	350 - #6	1 	2/0 - #14	2 	--
310	133x324	1/2/3	Thermo-Plastic	AL	350 - #6	1 	#8 - #14	24 	--
335	144x401	1/2/3	Phenolic	AL	400 - #6	1 	#2 - #14	6 	--
335	143x552	1/2/3	Phenolic	AL	400 - #6	1 	#2 - #14	4 	--
335	143x553	1/2/3	Phenolic	AL	400 - #6	1 	#2 - #14	6 	--
335	1343553	3	Thermo-Plastic	AL	400 - #6	1 	#2 - #14	6 	Yes
335	144x560	1/2/3	Phenolic	AL	400 - #6	1 	#2 - #14	8 	--
335	133x552	1/2/3	Thermo-Plastic	AL	400 - #6	1 	#2 - #14	4 	--
350	133x305	1/2/3	Thermo-Plastic	AL	2/0 - #14	2 	2/0 - #14	2 	--

# SPLICER/DISTRIBUTION



























AMPS	CATALOG #	POLES (x)	MATERIAL		LINE SIDE		LOAD SIDE		FEEDER CIRCUIT COMPLIANT PER UL 508
			INSULATOR	CONN.	WIRE RANGE AWG/kcmil	CONNECTOR OPENINGS/POLE	WIRE RANGE AWG/kcmil	CONNECTOR OPENINGS/POLE	
350	143x306	1/2/3	Phenolic	AL	2/0 - #14	2 	2/0 - #14	2 	--
350	143x555	1/2/3	Phenolic	AL	2/0 - #14	2 	#4 - #14	6 	--
350	133x555	1/2/3	Thermo-Plastic	AL	2/0 - #14	2 	#4 - #14	6 	--
350	1343555	3	Thermo-Plastic	AL	2/0 - #14	2 	#4 - #14	6 	Yes
350	143x955	1/2/3	Phenolic	CU	2/0 - #14	2 	#4 - #14	6 	--
350	133x955	1/2/3	Thermo-Plastic	CU	2/0 - #14	2 	#4 - #14	6 	--
380	143x953	1/2/3	Phenolic	CU	500 - #4	1 	#2 - #14	6 	--
380	133x953	1/2/3	Thermo-Plastic	CU	500 - #4	1 	#2 - #14	6 	--
380	144x551	1/2/3	Phenolic	AL	500 - #4	1 	#2 - #14	6 	--
380	145x579	1/2/3	Phenolic	AL	500 - #4	1 	#2/0 - #14	6 	--
380	133x587	1/2/3	Thermo-Plastic	AL	500 - #4	1 	#2 - #14 350 - #6	3/1 	--
380	143x587	1/2/3	Phenolic	AL	500 - #4	1 	#2 - #14 350 - #6	3/1 	--
380	145x594	1/2/3	Phenolic	AL	500 - #4	1 	#2 - #14	8 	--
380	145x552	1/2/3	Phenolic	AL	500 - #4	1 	#2 - #14	12 	--
420	144x557	1/2/3	Phenolic	AL	600 - #4	1 	600 - #4	1 	--
420	133x360	1/2/3	Thermo-Plastic	AL	600 - #2	1 	600 - #2	1 	--
420	133x588	1/2/3	Thermo-Plastic	AL	600 - #2	1 	#2 - #14 1/0 - #14	6/3 	--
420	1343588	3	Thermo-Plastic	AL	600 - #2	1 	#2 - #14 1/0 - #14	6/3 	Yes
420	133x595	1/2/3	Thermo-Plastic	AL	600 - #2	1 	#4 - #14	12 	--

# SPLICER/DISTRIBUTION

AMPS	CATALOG #	POLES (x)	MATERIAL		LINE SIDE		LOAD SIDE		FEEDER CIRCUIT COMPLIANT PER UL 508
			INSULATOR	CONN.	WIRE RANGE AWG/kcmil	CONNECTOR OPENINGS/POLE	WIRE RANGE AWG/kcmil	CONNECTOR OPENINGS/POLE	
420	1343595	3	Thermo-Plastic	AL	600 - #2	1 	#4 - #14	12 	Yes
420	133x585	1/2/3	Thermo-Plastic	AL	600 - #2	1 	#2 - #14	8 	--
420	1343585	3	Thermo-Plastic	AL	600 - #2	1 	#2 - #14	8 	Yes
420	133x575	1/2/3	Thermo-Plastic	AL	600 - #2	1 	2/0 - #14	4 	--
420	133x565	1/2/3	Thermo-Plastic	AL	600 - #2	1 	250 - #6	2 	--
420	135x601	1/2/3	Thermo-Plastic	AL	600 - #2	1 	#6 - #14	24 	--
475	135x701	1/2/3	Thermo-Plastic	AL	750 - 1/0	1 	750 - 1/0	1 	Yes <sup>1</sup>
510	133x320	1/2/3	Thermo-Plastic	AL	250 - #6	2 	250 - #6	2 	--
510	133x596	1/2/3	Thermo-Plastic	AL	250 - #6	2 	#4 - #14	12 	--
510	1343596	3	Thermo-Plastic	AL	250 - #6	2 	#4 - #14	12 	Yes
510	133x597	1/2/3	Thermo-Plastic	AL	250 - #6	2 	#2 - #14	8 	--
510	1343597	3	Thermo-Plastic	AL	250 - #6	2 	#2 - #14	8 	Yes
510	133x598	1/2/3	Thermo-Plastic	AL	250 - #6	2 	2/0 - #14	4 	--
620	145x129	1/2/3	Phenolic	AL	350 - #4	2 	350 - #4	2 	--
620	1331348	1	Thermo-Plastic	AL	350 - #4	2 	#8 - #14	48 	--
760	145x301	1/2/3	Phenolic	AL	500 - #4	2 	500 - #4	2 	--
760	145x592	1/2/3	Phenolic	AL	500 - #4	2 	#4 - #14	12 	--
760	145x586	1/2/3	Phenolic	AL	500 - #6	2 	2/0 - #14	8 	--



# SPLICER/DISTRIBUTION

AMPS	CATALOG #	POLES (x)	MATERIAL		LINE SIDE		LOAD SIDE		FEEDER CIRCUIT COMPLIANT PER UL 508
			INSULATOR	CONN.	WIRE RANGE AWG/kcmil	CONNECTOR OPENINGS/POLE	WIRE RANGE AWG/kcmil	CONNECTOR OPENINGS/POLE	
760	145x992	1/2/3	Phenolic	CU	500 - #4	2 	#2 - #14	12 	
760	145x986	1/2/3	Phenolic	CU	500 - #4	2 	2/0 - #14	8 	--
760	145x408	1/2/3	Phenolic	AL	500 - #6	2 	#2 - #14	12 	--
840	145x411	1/2/3	Phenolic	AL	600 - #2	2 	3/0 - #6 #4 - #14	4/4 	--
950	135x605	1/2/3	Thermo-Plastic	AL	600 - #2	2 	350 - #6	4 	--
950	135x702	1/2/3	Thermo-Plastic	AL	750 - 1/0	2 	750 - 1/0	2 	Yes <sup>1</sup>
950	135x703	1/2/3	Thermo-Plastic	AL	750 - 1/0	2 	250 - #6	6 	Yes <sup>1</sup>
950	135x704	1/2/3	Thermo-Plastic	AL	750 - 1/0	2 	2/0 - #14	10 	Yes <sup>1</sup>
950	135x705	1/2/3	Thermo-Plastic	AL	750 - 1/0	2 	#2 - #14 250 - #6	12/3 	Yes <sup>1</sup>
950	135x706	1/2/3	Thermo-Plastic	AL	750 - 1/0	2 	#2 - #14 250 - #6	4/5 	Yes <sup>1</sup>
950	135x707	1/2/3	Thermo-Plastic	AL	750 - 1/0	2 	#2 - #14 3/0 - #6	12/4 	Yes <sup>1</sup>
950	135x708	1/2/3	Thermo-Plastic	AL	750 - 1/0	2 	3/0 - #6	8 	Yes <sup>1</sup>
2280	1453401 <sup>2</sup>	1	Phenolic	AL	500 - #4	6 	2/0 - #14	18 	--

<sup>(1)</sup> UL Listed when purchased without a cover (CH). When purchased with a cover, the product is UL Recognized to US and Canadian standards (cURus).

<sup>(2)</sup> Special 1-pole power block with the dimensions of a 3-pole 145 series power block.

# HIGH VOLTAGE (1500V)

## ELECTRICAL:

350 - 1500 amps  
 1500 volts AC/DC (UL)  
 Flexible stranded wire compliant  
 Multiple wire ratings

## STANDARDS:

UL 1059 recognized file no. XCFR2.E62806  
 cUR recognized file no. XCFR8.E62806 (UL 1059)  
 RoHS compliant

## WEBSITE RESOURCES:

Detailed product data sheets

- Material information
- Termination & mounting specifications
- Detailed SCCR information

Dimensional drawings & 3D CAD files

Accessories available

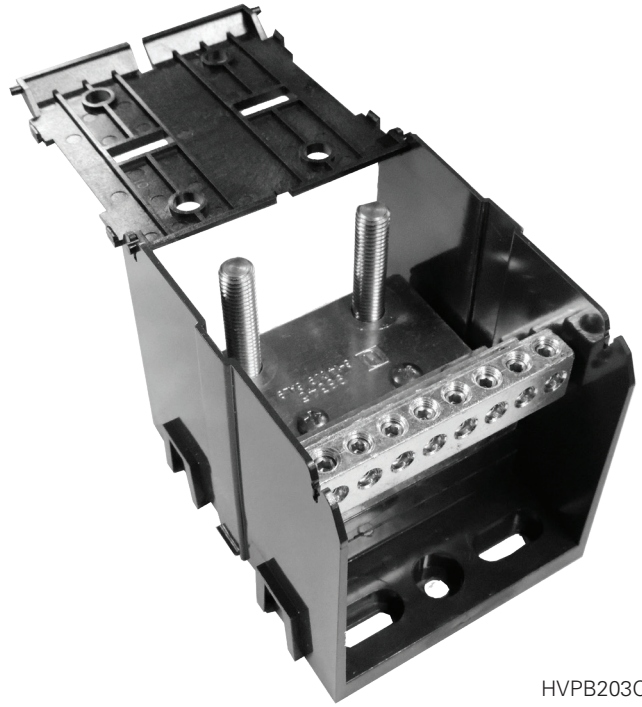

HVPB203CH

## ORDERING CODE:

### SERIES

HVPB

High Voltage  
 Power Block

### IDENTIFIER









XXX

Random  
 3-digit  
 Identifier





























### COVER OPTION

XX

Blank = No Cover  
 CH = Snap-On (Hinge)  
 Cover Attached

AMPS	CATALOG #	POLES (x)	CONNECTOR TEMP RATING	MATERIAL		LINE SIDE		LOAD SIDE	
				INSULATOR	CONN.	WIRE RANGE AWG/kcmil	CONNECTOR OPENINGS/POLE	WIRE RANGE AWG/kcmil	CONNECTOR OPENINGS/POLE
350	HVPB105	1	90° C	Thermo-Plastic	AL	Stud, M10	1 	#10 - #14 <sup>(a)</sup>	24 
420	HVPB108	1	75° C	Thermo-Plastic	AL	600 - #2	1 	#4 - #14	12 
420	HVPB109	1	75° C	Thermo-Plastic	AL	600 - #2	1 	600 - #2	1 
430	HVPB101	1	90° C	Thermo-Plastic	AL	Stud, M10	1 	#6 - #14 <sup>(b)</sup>	12 

# HIGH VOLTAGE (1500V)

AMPS	CATALOG #	POLES (x)	CONNECTOR TEMP RATING	MATERIAL		LINE SIDE		LOAD SIDE	
				INSULATOR	CONN.	WIRE RANGE AWG/kcmil	CONNECTOR OPENINGS/POLE	WIRE RANGE AWG/kcmil	CONNECTOR OPENINGS/POLE
430	HVPB103	1	90°C	Thermo-Plastic	AL	Stud, M10	1 	#4 - #14 <sup>(c)</sup>	8 
430	HVPB107	1	90°C	Thermo-Plastic	CU	Stud, M10	1 	Stud, M10	1 
430	HVPB208	1	90°C	Thermo-Plastic	CU	Stud, 1/2-13 x 1.44"	1 	Stud, 1/2-13 x 1.44"	1 
750	HVPB112	1	90°C	Thermo-Plastic	CU	Stud, 3/8	1 	Stud, 3/8	1 
750	HVPB114	1	90°C	Thermo-Plastic	CU	Stud, 1/2	1 	Stud, 1/2	1 
760	HVPB210	1	75°C	Thermo-Plastic	AL	500 - #4	2 	#2 - #14	12 
760	HVPB211	1	75°C	Thermo-Plastic	AL	500 - #4	2 	2/0 - #14	8 
860	HVPB205	1	90°C	Thermo-Plastic	AL	Stud, M10	1 	#4 - #14 <sup>(c)</sup>	16 
860	HVPB207	1	90°C	Thermo-Plastic	AL	Stud, M10	2 	#4 - #14 <sup>(c)</sup>	16 
860	HVPB201	1	90°C	Thermo-Plastic	AL	Stud, M10	1 	#6 - #14 <sup>(b)</sup>	24 
860	HVPB203	1	90°C	Thermo-Plastic	AL	Stud, M10	2 	#6 - #14 <sup>(b)</sup>	24 
950	HVPB602	1	90°C	Thermo-Plastic	AL	600 - #2	2 	600 - #2	2 
1500	HVPB212	1	90°C	Thermo-Plastic	CU	Stud, 3/8	2 	Stud, 3/8	2 
1500	HVPB214	1	90°C	Thermo-Plastic	CU	Stud, 1/2	2 	Stud, 1/2	2 

(a) suitable for #8 AWG, limited to 40A per wire, copper only  
 (b) suitable for #4 AWG, limited to 75A per wire, copper only  
 (c) suitable for #2 AWG, limited to 95A per wire, copper; 75A per wire, aluminum



# STUD CONFIGURATIONS

## ELECTRICAL:

115 to 1680 amps  
600 volts AC/DC (UL)  
Flexible stranded wire compliant  
Multiple wire ratings

## STANDARDS:

UL 1059 recognized file no. XCFR2.E62806  
CSA certified file no. LR19766 (CSA C22-2 No. 158)  
CE (Component IEC 60947-7-1)  
RoHS compliant (all)

## WEBSITE RESOURCES:

Detailed product data sheets

- Material information
- Termination & mounting specifications
- Multiple wire rating specifications
- Detailed SCCR information

Dimensional drawings & 3D CAD files

Accessories available

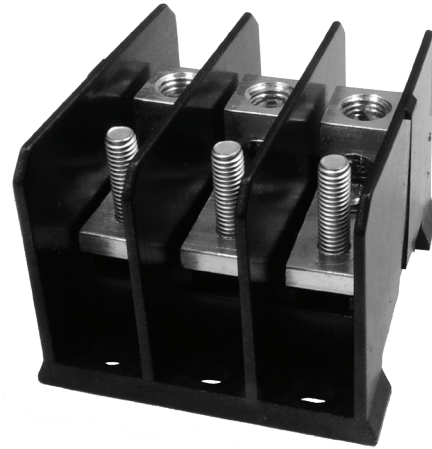

1413203



1423122



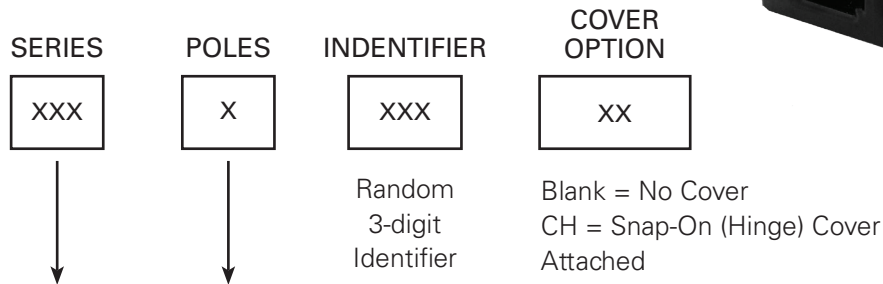





















## ORDERING CODE:





























SERIES	POLES (x)	DIMENSIONS (INCHES)			COVER TYPE AVAILABLE
		WIDTH	LENGTH	HEIGHT	
132	0/1/2/3	2.54	3.00	2.42	SNAP-ON
133	1/2/3	5.36	4.00	3.33	SNAP-ON
135	1/2/3	10.08	5.73	4.77	SNAP-ON
140	2/3	5.38	2.90	2.06	SCREW-ON
141	1/2/3/4	2.12	2.29	1.62	SCREW-ON
142	1/2/3	2.75	2.88	1.78	SCREW-ON
143	1/2/3	5.00	4.00	2.61	SCREW-ON
144	1/2/3	6.03	4.75	2.91	SCREW-ON
145	1/2/3	8.54	5.50	3.13	SCREW-ON

\*Covers can be found on Page 21

# STUD CONFIGURATIONS

AMPS	CATALOG #	POLES (x)	MATERIAL		LINE SIDE		LOAD SIDE	
			INSULATOR	CONN.	WIRE RANGE AWG/kcmil	CONNECTOR OPENINGS/POLE	WIRE RANGE AWG/kcmil	CONNECTOR OPENINGS/POLE
115	141x203	1/2/3/4	Thermo-Plastic	AL	#2 - #14	1 	#10-32 X .60	1 
175	132x574	0/1/2/3	Thermo-Plastic	AL	2/0 - #14	1 	1/4-20 x .50	1 
175	132x474	0/1/2/3	Thermo-Plastic	AL	2/0 - #14	1 	M6 X 13	1 
175	142x574	1/2/3	Phenolic	AL	2/0 - #14	1 	1/4-20 X .50	1 
175	143x590	1/2/3	Phenolic	AL	2/0 - #14	1 	1/4-20 X 1.38	1 
200	132x122	0/1/2/3	Thermo-Plastic	CU	1/4-20 X .56	1 	1/4-20 X .56	1 
200	132x422	0/1/2/3	Thermo-Plastic	CU	M6 X 15	1 	M6 X 15	1 
200	142x122	1/2/3	Phenolic	CU	1/4-20 X .56	1 	1/4-20 X .56	1 
230	143x563	1/2/3	Phenolic	CU	3/8-16 x 1.18	1 	3/8-16 x 1.18	1 
230	143x561	1/2/3	Phenolic	CU	3/8-16 x 1.18	1 	1/4-20 x 1.38	1 
230	144x553	1/2/3	Phenolic	CU	3/8-16 x 1.44	1 	3/8-16 x 1.44	1 
260	144x122	1/2/3	Phenolic	CU	3/8-16 x 1.44	1 	1/4-20 X .56	2 
310	133x564	1/2/3	Thermo-Plastic	CU	M10 x 30	1 	M10 x 30	1 
310	133x563	1/2/3	Thermo-Plastic	CU	3/8-16 x 1.18	1 	3/8-16 x 1.18	1 
310	143x559	1/2/3	Phenolic	AL	350 - #6	1 	3/8-16 x 1.13	1 
310	133x559	1/2/3	Phenolic	AL	350 - #6	1 	3/8-16 x 1.25	1 
310	133x558	1/2/3	Phenolic	AL	350 - #6	1 	M10 x 30	1 
360	145x573	1/2/3	Phenolic	CU	3/8-16 x 1.44	1 	3/8-16 x 1.44	2 
360	145x583	1/2/3	Phenolic	CU	3/8-16 x 1.44	1 	1/4-20 x 1.44	2 

## STUD CONFIGURATIONS

AMPS	CATALOG #	POLES (x)	MATERIAL		LINE SIDE		LOAD SIDE	
			INSULATOR	CONN.	WIRE RANGE AWG/kcmil	CONNECTOR OPENINGS/ POLE	WIRE RANGE AWG/kcmil	CONNECTOR OPENINGS/ POLE
380	144x569	1/2/3	Phenolic	AL	500 - #4	1 	1/4-20 x 1.06	2 
380	144x575	1/2/3	Phenolic	AL	500 - #4	1 	3/8-16 x 1.31	1 
410	145x606	1/2/3	Phenolic	CU	1/2-13 x 1.44	1 	1/2-13 x 1.44	1 
410	133x611	1/2/3	Thermo-Plastic	CU	1/2-13 x 1.38	1 	1/2-13 x 1.38	1 
475	145x613	1/2/3	Phenolic	CU	3/8-16 x 1.44	2 	3/8-16 x 1.44	1 
510	133x272	1/2/3	Thermo-Plastic	AL	3/8-16 x 1.19	1 	4 - #14	12 
510	133x280	1/2/3	Thermo-Plastic	AL	3/8-16 x 1.19	1 	#2 - #14	8 
510	133x270	1/2/3	Thermo-Plastic	AL	3/8-16 x 1.19	1 	2/0 - #14	4 
760	145x282	1/2/3	Phenolic	AL	3/8-16 x 1.00	2 	2/0 - #14	8 
760	145x599	1/2/3	Phenolic	AL	500 - #4	2 	3/8-16 x 1.31	2 
760	145x610	1/2/3	Phenolic	AL	500 - #4	2 	1/2-13 x 1.31	1 
840	144x614	1/2/3	Phenolic	CU	3/8-16 x 1.00	1 	3/8-16 x 1.00	1 
1680	145x615	1/2/3	Phenolic	AL	600 - #4	4 	1/2-13 x 1.56	1 



# MISC CONFIGURATIONS

## ELECTRICAL:

115 to 200 amps  
 600 volts AC/DC (UL)  
 Flexible stranded wire compliant  
 Multiple wire ratings

## STANDARDS:

UL 1059 recognized file no. XCFR2.E62806  
 CSA certified file no. LR19766 (CSA C22-2 No. 158)  
 CE (Component IEC 60947-7-1)  
 RoHS compliant (all)

## WEBSITE RESOURCES:

Detailed product data sheets

- Material information
- Termination & mounting specifications
- Multiple wire rating specifications
- Detailed SCCR information

Dimensional drawings & 3D CAD files

















Accessories available



1413202



1413301

AMPS	CATALOG #	POLES (x)	MATERIAL		LINE SIDE		LOAD SIDE	
			INSULATOR	CONN.	WIRE RANGE AWG/kcmil	CONNECTOR OPENINGS/POLE	WIRE RANGE AWG/kcmil	CONNECTOR OPENINGS/POLE
115	141x201	1/2/3/4	Thermo-Plastic	AL	#2 - #14	1 	#10-32 Tapped Hole	1 
115	141x202	1/2/3/4	Thermo-Plastic	AL	#2 - #14	1 	1/4" Quick-connects (4)	4 
115	141x205	1/2/3/4	Thermo-Plastic	AL	#2 - #14	1 	1/4" Quick-connects (2) & #10-32 Tap	2/1 
115	141x301	1/2/3/4	Thermo-Plastic	AL	#2 - #14	1 	#2 - #14 & 1/4" Quick-connect (1)	1/1 
175	142x553	1/2/3	Phenolic	AL	2/0 - #14	1 	1/4 - 20 Tapped Hole	1 
175	132x579	1/2/3	Thermo-Plastic	AL	2/0 - #14	1 	2/0 - #14 & (1) Quick-connect	1/1 
175	132x670	1/2/3	Thermo-Plastic	AL	2/0 - #14	1 	#4 - #14 & (1) Quick-connect	4/1 
200	142x123	1/2/3	Phenolic	CU	1/4-20 Screw	1 	1/4 - 20 Screw	1 

## COVERS

SERIES	TYPE	CATALOG # (replace x with # of poles)	POLES (x)	FIGURE #
132	SNAP-ON	CH132x	1/2/3	3
133	SNAP-ON	CH133x	1/2/3	3
134	SNAP-ON	CH1343	3	4
135	SNAP-ON	CH1351	1	5
140	SCREW-ON	CC140x	2/3	1
141	SNAP-ON	CC141x	1/2/3/4	2
142	SCREW-ON	CC142x	1/2/3	1
143	SCREW-ON	CC143x	1/2/3	1
144	SCREW-ON	CC144x	1/2/3	1
145	SCREW-ON	CC145x	1/2/3	1
HVPB1	SNAP-ON	CH1331	1	5
HVPB2	SNAP-ON	CH1332	1	5

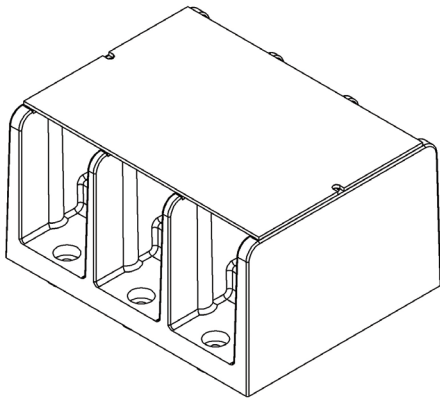

FIGURE 1

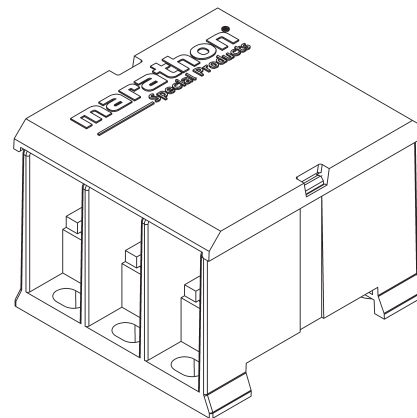

FIGURE 2

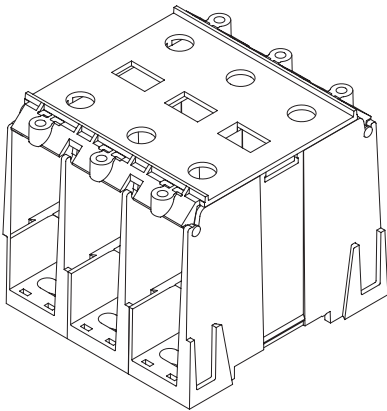

FIGURE 3

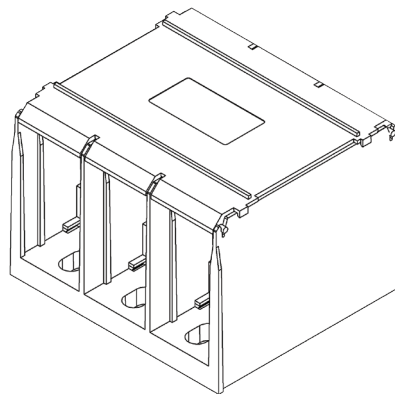

FIGURE 4

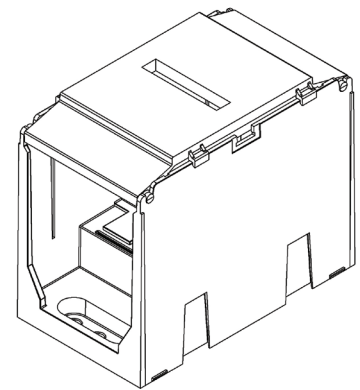

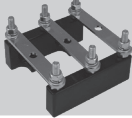









FIGURE 5

# TERMINAL BLOCK TYPES

TERMINAL BLOCK TYPE	PAGE #	DESCRIPTION	IMAGE
Studded Feed-Thru	23	Feed-thru terminal blocks are commonly used in telecom panel power distribution units (PDU's) and other applications where external power needs to be transferred to feed a circuit.	
Single Stud Connection	25	Single stud terminals simply provide a single junction point to connect two or more ring type terminals.	
Motor Blocks	26	Motor terminal blocks are specifically intended to be used with electric motor junction boxes to provide delta or wye wiring configurations.	
Grounding Lugs & Connectors	27	These wiring components are intended to be used for grounding in electrical systems.	
Deadfront	28	These rugged terminal blocks provide protection from direct contact with live terminals.	
Barrier	30	These robust style of terminal strips are commonly used in utility panels to aide in the control of power generation and transmission equipment.	
Double Row	31	Barrier terminal strips are the most cost effective means of junctioning wires in lower power applications. Various hardware accessories are available to meet circuit requirements.	
Single Row	33	These terminals are intended for junctioning wires at a single point by means of a bare wire, prepared wire or hardware (quick-connects).	
Military / Navy	35	These terminal blocks are constructed to meet the requirements of Military Specifications A-A-59125 & MIL-T-55164-C, and are only to be used in applications requiring compliance with these specifications.	
DIN Sectionals	37	DIN sectionals provide a compact semi-touch proof construction for a range of wire sizes. These provide end-users the ability to construct terminals to various line lengths per application.	
NEMA® Sectionals	39	NEMA sectionals have an open barrier appearance and style in a sectional construction to provide end-users the ability to construct terminals to various line lengths per application.	

TERMINAL BLOCKS

## Website Resources:

- Dimensional drawings & 3D CAD files
- Termination and mounting specifications
- Detailed product/series datasheets
- Check distributor stock
- Request samples

NEMA is a trademark of National Electrical Manufacturers Association. All Rights Reserved.



# STUDED FEED-THRU

## ELECTRICAL:

115 to 175 amps  
 300 volts AC/DC (UL)  
 Wire range is determined by the compression lugs used  
 Short circuit current rating (SCCR) of 10K  
 Factory and field wiring

## STANDARDS:

UL 1059 recognized file no. XCFR2.E62806  
 CSA certified file no. LR19766 (CSA C22-2 No. 158)  
 CE (Component IEC 60947-7-1)  
 RoHS compliant (All)

## WEBSITE RESOURCES:

Detailed product data sheets

- Material information
- Termination & mounting specifications
- Multiple wire rating specifications
- Detailed SCCR information

Dimensional drawings & 3D CAD files  
 Accessories available

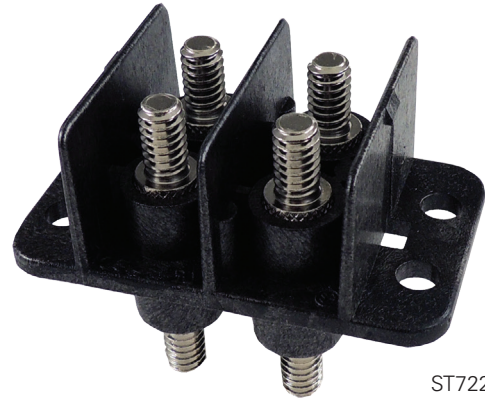

ST722E2502

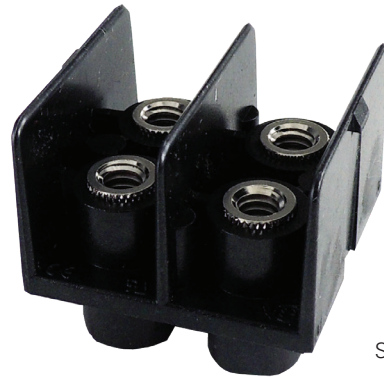

ST722B2502T2

## ORDERING CODE:

SERIES	MOUNTING STYLE (x)	THREAD SIZE (xx)	POLES (xx)	TERMINAL OPTIONS	HARDWARE OPTIONS
ST722	B = Back Mount E = End Mount	25 = 1/4-20 19 = #10-32 M6 = M6 M5 = M5	01 / 02 / 03 / 04 / 05 / 06	Blank = Studs Top & Bot. T1 = Tap Top, Stud Bot. T1S = Stud Top, Tap Bot. T2 = Tap Top & Bot.	Blank – No hardware UH – All nuts shipped bulk AH – All nuts assembled DL – Assembled barrier side, remainder shipped bulk

## COVERS AVAILABLE:

Covers fit all styles available

CATALOG NUMBER	POLES (x)	BASE	FLAMMABILITY
C72201	1	Thermoplastic	UL 94 V-0
C72202	2	Thermoplastic	UL 94 V-0
C72203	3	Thermoplastic	UL 94 V-0
C72204	4	Thermoplastic	UL 94 V-0
C72205	5	Thermoplastic	UL 94 V-0
C72206	6	Thermoplastic	UL 94 V-0

# STUDED FEED-THRU

## ELECTRICAL:

Volts / amps - see table  
 Wire range is determined by the compression lugs used  
 Short circuit current rating (SCCR) of 10K  
 Factory and field wiring

## STANDARDS:

UL 1059 recognized file no. XCFR2.E62806  
 CSA certified file no. LR19766 (CSA C22-2 No. 158)  
 CE (Component IEC 60947-7-1)  
 RoHS compliant (All)

## WEBSITE RESOURCES:

Detailed product data sheets

- Material information
- Termination & mounting specifications
- Multiple wire rating specifications
- Detailed SCCR information

Dimensional drawings & 3D CAD files  
 Accessories available

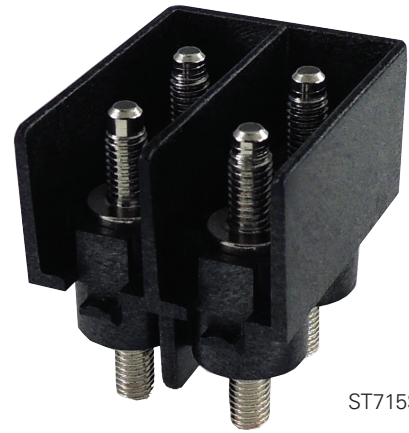

ST715S1902

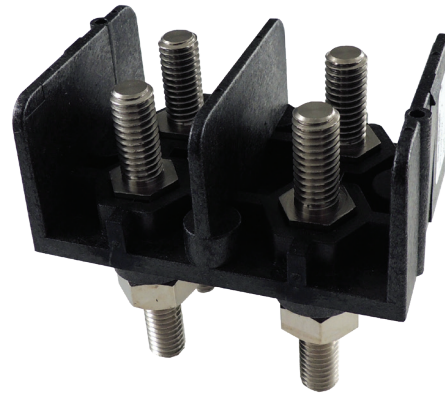

ST723B3802

## ORDERING CODE:

VOLTS	AMPS	SERIES	POLES (xx)	HARDWARE OPTIONS
300	80	ST715S19xx	02	Blank – No hardware UH – All nuts shipped bulk AH – All nuts assembled DL – Assembled barrier side, remainder shipped bulk
600	380	ST723B38xx	01/02	Blank – No hardware UH – All nuts shipped bulk AH – All nuts assembled DL – Assembled barrier side, remainder shipped bulk

# SINGLE STUD CONNECTION

## ELECTRICAL:

300 volts AC/DC (UL)

Designed for two or more wire terminals

## STANDARDS:

RoHS compliant (All)

## WEBSITE RESOURCES:

Detailed product data sheets

- Material information
- Termination & mounting specifications

Dimensional drawings & 3D CAD files

Accessories available

## ORDERING CODE:

CATALOG #	INSULATOR COLOR	STUD SIZE
ST 710 31	Black	5/16"
ST 710 31 RED	Red	5/16"
ST 710 38	Black	3/8"
ST 710 38 RED	Red	3/8"



ST 710 38



ST 710 31 RED

# MOTOR (IEC STYLE)

## ELECTRICAL:

Amps - see table  
 250 - 1100 volts  
 Designed for delta and WYE wiring configurations  
 For use with listed crimp lugs

## STANDARDS:

UL 1059 recognized file no. XCFR2.E62806  
 CSA certified file no. LR19766 (CSA C22-2 No. 158)  
 CE compliant - UL investigated to IEC 60947-7-1, file no. XCHG2.E243117, IEC 60947-7-1  
 UL investigated to SANS 1804-2  
 RoHS compliant (All)

## WEBSITE RESOURCES:

Detailed product data sheets

- Material information
- Termination & mounting specifications
- Multiple wire rating specifications
- Detailed SCCR information

Dimensional drawings & 3D CAD files  
 Accessories available

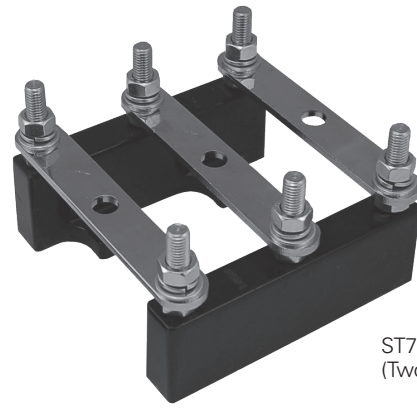

ST750M12  
 (Two Piece Style)



ST750M8  
 (One Piece Style)

TERMINAL BLOCKS

CATALOG #	STUD SIZE	STYLE	AMPS		VOLTAGE			WIRE RANGE	OVERALL DIMENSIONS (L x W x H) MM
			cURus	IEC	cURus	IEC	Sans 1804		
ST755M4	M4	One Piece	38	50	300	630	250	#8 - #18 AWG	55 x 33 x 43
ST750M4	M4	One Piece	35	50	1000	1000	1100	#8 - #18 AWG	63 x 37 x 42
ST755M5	M5	One Piece	50	50	600	800	660	#8 - #16 AWG	68 x 40 x 45
ST750M6	M6	One Piece	101	121	1000	1000	1100	#2 - #14 AWG	85 x 50 x 62
ST750M8	M8	One Piece	160	185	1000	1000	1100	2/0 - #12 AWG	112 x 69 x 76
ST755M10	M10	One Piece	185	217	1000	1000	1100	3/0 - #8 AWG	140 x 86 x 91
ST755M12	M12	One Piece	242	271	1000	1000	1100	250 kcmil - #8 AWG	170 x 110 x 97
ST750M12	M12	Two Piece	315	374	1000	1000	1100	400 kcmil - #8 AWG	179 x 167 x 107
ST750M16	M16	Two Piece	560	520	1000	1000	1100	(2) 300 kcmil - (2) #2 AWG	201 x 191 x 133

All blocks include links and hardware assembled



# GROUNDING LUGS & CONNECTORS

## ELECTRICAL:

See table

## STANDARDS:

UL recognized file no. ZMVF2.E43665 (excludes KT375)  
 Supplemental UL Certification: Grounding and bonding equipment (KDER)  
 CSA certified file no. 63510-25  
 Green screwhead for ID (GLxx's only)  
 RoHS compliant (all)

## WEBSITE RESOURCES:

Detailed product data sheets

- Material information
- Termination & mounting specifications

Dimensional drawings & 3D CAD files  
 Accessories available

TERMINAL BLOCKS

CATALOG #	WIRE RANGE AWG/kcmil	MOUNTING HOLE DIAMETER
GL02* (9807052)	#2 - #3	.27
	#4 - #6	.27
	#8	.27
	#10 - #14	.27

\*For hex drive screw, catalog number is GL02IH

CATALOG #	WIRE RANGE AWG/kcmil	MOUNTING HOLE DIAMETER
GL20 (9818102)	2/0 - #6	.41
	#8	.41
	#10 - #14	.41

CATALOG #	WIRE RANGE AWG/kcmil	MOUNTING HOLE DIAMETER
GL35 (9819830)	350 kcmil - #6	.53

CATALOG #	WIRE RANGE AWG/kcmil	MOUNTING HOLE DIAMETER
WC12044 (9740701)	(1) 2/0 - #14	.21
	(4) #4 - #14	

CATALOG #	WIRE RANGE AWG/kcmil	MOUNTING HOLE DIAMETER
WC12064 (9797110)	(1) 2/0 - #14	.21
	(6) #4 - #14	

CATALOG #	WIRE RANGE AWG/kcmil	MOUNTING HOLE DIAMETER
KT375	1/4" Quick-connect	.13

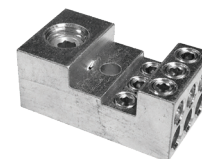
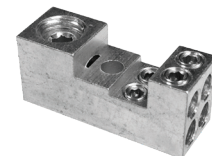
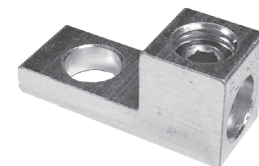
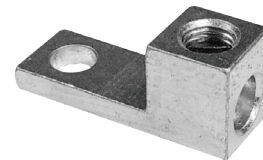

# 1100 & 1200 SERIES

## ELECTRICAL:

Amps - see table  
 600 volts AC/DC  
 Short circuit current rating (SCCR) of 10K

## STANDARDS:

UL 1059 recognized file no. XCFR2.E62806  
 CSA certified file no. LR19766 (CSA C22-2 No. 158)  
 CE (Component IEC 60947-7-1)  
 RoHS compliant (All)

## WEBSITE RESOURCES:

Detailed product data sheets

- Material information
- Termination & mounting specifications
- Multiple wire rating specifications

Dimensional drawings & 3D CAD files  
 Accessories available



1104



1206

AMPS	SERIES	CATALOG #	POLES (x)	WIRE RANGE	POLE TO POLE	SCREWS
65	1100	1102	2	#6 - 18 AWG CU #6 - 12 AWG AL	.44	Brass, Tin Plated
		1104	4			
		1106	6			
		1107	7			
		1108	8			
70	1200	1202	2	#4 - 18 AWG CU	.50	Steel, Nickel Plated
		1204	4			
		1206	6			

TERMINAL BLOCKS

# 0987 RZ, 985 GP & 885 RZ SERIES

## ELECTRICAL:

Amps - see table  
 600 volts AC/DC  
 Short circuit current rating (SCCR) of 10K

## STANDARDS:

UL 1059 recognized file no. XCFR2.E62806  
 CSA certified file no. LR19766 (CSA C22-2 No. 158)  
 CE (Component IEC 60947-7-1)  
 IP20 touch proof (0987 only)  
 RoHS compliant (All)

## WEBSITE RESOURCES:

Detailed product data sheets

- Material information
- Termination & mounting specifications
- Multiple wire rating specifications

Dimensional drawings & 3D CAD files  
 Accessories available

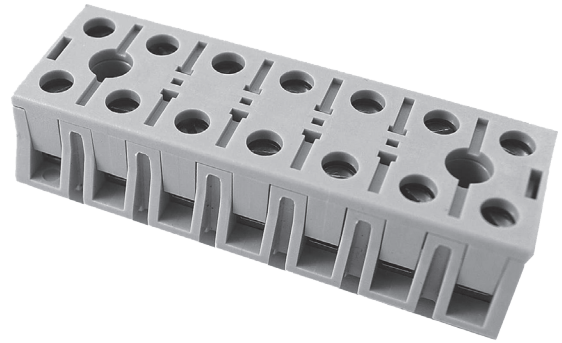

0987 RZ TC 07

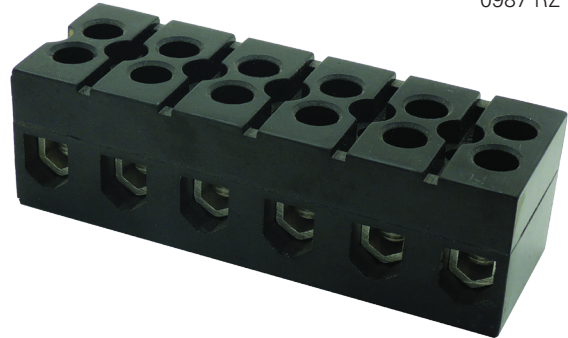

985 GP 06



885 RZ 12

AMPS	CATALOG #	POLES (xx)	WIRE RANGE	INSULATOR BASE	CENTERLINE SPACING
50	0987 RZ TC xx	02, 03, 04, 05, 06, 07, 08, 09, 10, 11, 12	#8 - 24	Thermoplastic, 125°C (UL RTI)	.475"
85	985 GP xx	02, 03, 04, 05, 06, 07, 08, 09, 10, 11, 12	#4 - 18	Phenolic, 150°C (UL RTI)	.625"
85	885 RZ xx	01, 02, 03, 04, 05, 06, 07, 08, 09, 10, 11, 12	#4 - 18	Thermoplastic, 130°C (UL RTI)	.432"

# 1500, 1600 & 1700 SERIES

## ELECTRICAL:

Amps

- 75 w/ prepared wire
- 30 w/ bare wire

600 volts AC/DC

Bare wire range #10 - 22 AWG CU

Accepts lugs with max width of .50 inches

Short circuit current rating (SCCR) of 10K

## STANDARDS:

UL 1059 recognized file no. XCFR2.E62806

CSA certified file no. LR19766 (CSA C22-2 No. 158)

CE (Component IEC 60947-7-1)

RoHS compliant (All)

## WEBSITE RESOURCES:

Detailed product data sheets

- Material information
- Termination & mounting specifications
- Multiple wire rating specifications

Dimensional drawings & 3D CAD files

Accessories available



1512 STD

SERIES	BASE CATALOG #	POLES (xx)	INSULATOR BASE	PITCH (POLE TO POLE SPACING)	CLEAR COVER	WHITE COVER
1500	15xx	02, 04, 06, 08, 12	Phenolic (150°C UL RTI)	0.625	CC 15xx	CW 15xx
1600	16xx	02, 04, 06, 08, 12	Phenolic (150°C UL RTI)	0.656	CC 16xx	CW 16xx
1700	17xx	02, 03, 04, 05, 06, 07, 08, 09, 10, 11, 12	Thermoplastic (125°C UL RTI)	0.625	CC 17xx	--

## SERIES CONFIGURATION OPTIONS

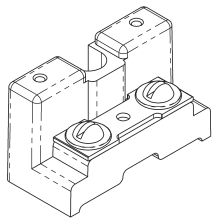
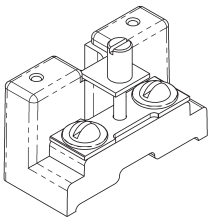
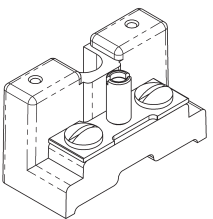
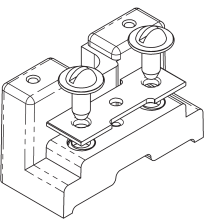
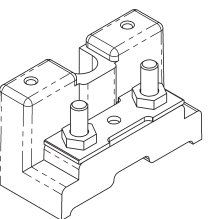
STD	SC	TP	DJ	STRC <sup>1</sup>
1500 1600 1700	1500 1600 1700	1500 1600	1500 1600	1500 1600
				
Standard Connector	Short Circuiting Bar with Brass Insert, 4 Shorting Pins per Block	Test Point, Integrated Female Banana Plug	Removable Connector with Brass Insert	10-32 Stud, Terminals

<sup>1</sup>Stud construction with a removable connector is available as option "ST".



# DOUBLE ROW TERMINAL BLOCKS

**DOUBLE ROW TERMINAL BLOCKS** come in three basic options dependent on base material and style:

- **CLOSED BACK, THERMOPLASTIC** - the ideal option for standard configurations. Generally, these are the most cost effective and are more robust than any other style.
- **CLOSED BACK, PHENOLIC** - this is the second best option for standard configurations where temperature ratings are between 125° C and 150° C.
- **OPEN BACK, PHENOLIC** - should be used only for feed-thru hardware options, and requires an additional insulator strip in order to attain the noted voltage rating.

## ELECTRICAL:

Amps & volts - see table

## STANDARDS:

UL recognized file no. XCFR2.E62806 or E47811  
 CSA certified file no. LR19766 (CSA C22-2 No. 158)  
 CE (Component IEC 60947-7-1)  
 RoHS compliant (All)

## WEBSITE RESOURCES:

Dimensional drawings & 3D CAD files  
 Termination and mounting specifications  
 Detailed product/series data sheets  
 Hardware options per series

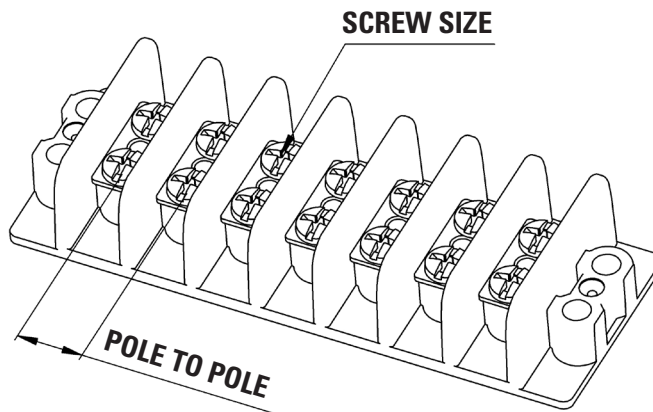

SERIES	AMPS	VOLTAGE CLASS B/C	BARE WIRE RANGE	MAX LUG WIDTH	SCREW SIZE	INCHES L TO L	POLES (xx)	WIDTH (INCHES)	HEIGHT (INCHES)	BASE MATERIAL	STYLE
670A RZ	20	300/150	#12-22	0.31	#6-32	0.375	1-30	0.87	0.48	Thermoplastic	Closed Back
621 RZ	30	600/600	#12-22	0.33	#6-32	0.437	1-30	1.38	0.75	Thermoplastic	Closed Back
671 RZ	30	300/150	#14-22	0.33	#6-32	0.437	1-30	1.13	0.53	Thermoplastic	Closed Back
672 RZ	30	600/600	#12-14	0.41	#8-32	0.562	1-24	1.31	0.71	Thermoplastic	Closed Back
670A GP (100)	20	250/NA	#12-22	0.30	#6-32	0.375	1-36	0.88	0.44	Phenolic	Closed Back
671 GP (200)	30	300/150	#14-22	0.34	#6-32	0.437	1-30	1.12	0.53	Phenolic	Closed Back
672 GP (300)	30	NA/600	#10-14	0.42	#8-32	0.562	1-24	1.31	0.71	Phenolic	Closed Back
400	30	NA/600	#10-22	0.47	#10-32	0.687	1-12	1.81	0.75	Phenolic	Closed Back
410	5	300/NA	#18-20	0.19	#2-56	0.25	1-23	0.63	0.32	Phenolic	Open Back
600	15	300/300	#14-22	0.30	#5-40	0.375	1-22	0.87	0.41	Phenolic	Open Back
600A	15	300/300	#12-22	0.30	#6-32	0.375	1-22	0.87	0.41	Phenolic	Open Back
601	20	300/300	#12-22	0.34	#6-32	0.437	1-23	1.13	0.50	Phenolic	Open Back
801	20	NA/150	#10	RIVET	#6-32	0.437	1-23	1.13	0.50	Phenolic	Open Back
602	30	300/300	#10-18	0.44	#8-32	0.562	1-26	1.32	0.64	Phenolic	Open Back
802	30	NA/150	#10	RIVET	#8-32	0.562	1-26	1.32	0.64	Phenolic	Open Back
603	50	600/600	#10-16	0.47	#10-32	0.687	1-12	1.81	0.75	Phenolic	Open Back
604	70	600/600	#10-14	0.58	#12-32	0.875	1-8	2.00	0.94	Phenolic	Open Back
605	90	600/600	#10-14	0.67	1/4-28	1.125	1-6	2.48	1.13	Phenolic	Open Back

# DOUBLE ROW ACCESSORIES

**DOUBLE ROW HARDWARE GENERAL OPTIONS** - see on-line product page for details and compatibility with each terminal block series.

## QUICK CONNECT (KT) OPTIONS:

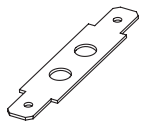

(2) 0° tabs

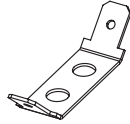

(2) 45° tabs

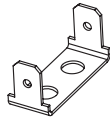

(2) 90° tabs

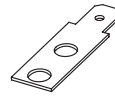

(1) 0° tab



(1) 45° tab

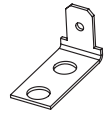

(1) 90° tab

## JUMPERS:

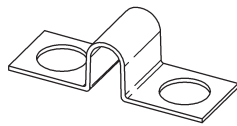

Pole to Pole

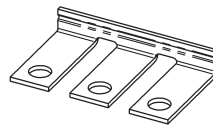

RJ

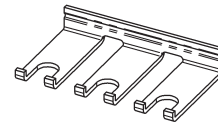

RJS

## SCREW & STUD OPTIONS:



Standard or "PSB"



"SEMS" or "SP"

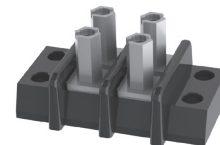

Stud Options

## SOLDER COMPONENTS - FEED-THRU AND OVER THE SIDE:

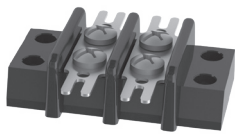

"ST"



"3/4 ST"



"Y"



"YSY"

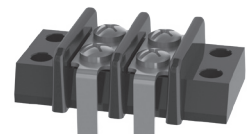

"Z"

## COVERS & MARKING STRIPS:

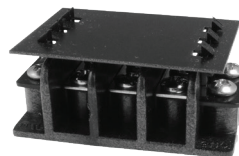
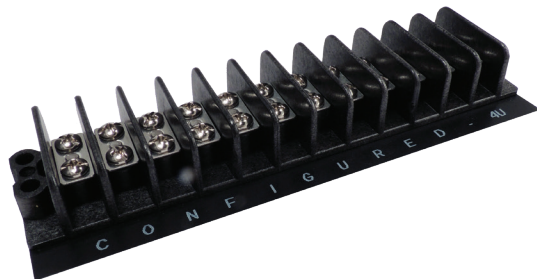

# SINGLE ROW TERMINAL BLOCKS

**SINGLE ROW TERMINAL BLOCKS** all consist of our classic open back, phenolic design that requires an additional insulator strip in order to achieve the noted voltage rating.

**ELECTRICAL:**

Amps & volts - see table

**STANDARDS:**

UL recognized file no. XCFR2.E47811  
 CSA certified file no. LR19766  
 CE compliant (IEC 60947-7-1)  
 RoHS compliant

**WEBSITE RESOURCES:**

Dimensional drawings & 3D CAD files  
 Termination and mounting specificatio  
 Detailed product/series data sheets  
 Hardware options per series

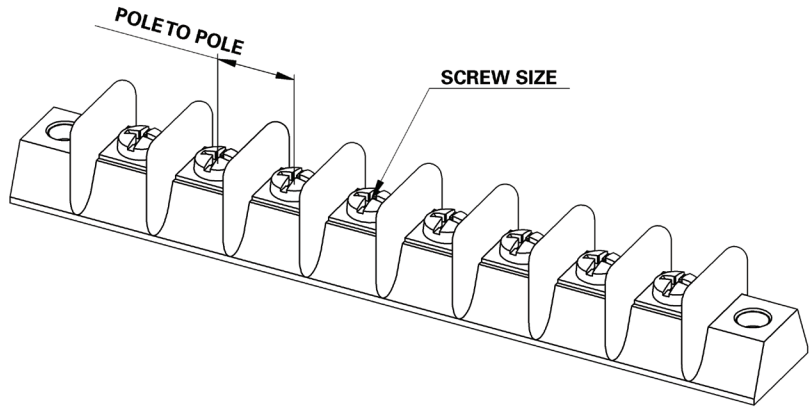

SERIES	AMPS	VOLTAGE CLASS B/C	BARE WIRE RANGE	MAX LUG WIDTH	SCREW SIZE	INCHES L TO L	# OF LINES	WIDTH (INCHES)	HEIGHT (INCHES)	BASE MATERIAL	STYLE
411	5	300/NA	#18-20	0.19	#2-56	0.25	1-23	0.41	0.31	Phenolic	Open Back
599	15	300/150	#16-22	0.30	#5-40	0.375	1-30	0.56	0.41	Phenolic	Open Back
799	15	NA/150	#14	RIVET	#5-40	0.375	1-30	0.56	0.41	Phenolic	Open Back
699	20	300/150	#14-20	0.33	#6-32	0.437	1-23	0.69	0.50	Phenolic	Open Back
899	20	NA/150	#14	RIVET	#6-32	0.437	1-23	0.69	0.50	Phenolic	Open Back
812	30	600/600	#12-14	0.41	#8-32	0.562	1-18	0.75	0.72	Phenolic	Open Back
912	30	NA/300	#10	RIVET	#8-32	0.562	1-18	0.75	0.72	Phenolic	Open Back

# SINGLE ROW ACCESSORIES

**SINGLE ROW HARDWARE GENERAL OPTIONS** - see on-line product page for details and compatibility with each terminal block series.

## QUICK CONNECT (KT) OPTIONS:

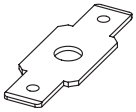

(2) 0° tabs



(2) 45° tabs

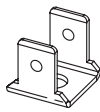

(2) 90° tabs

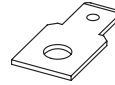

(1) 0° tab

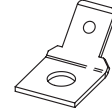

(1) 45° tab



(1) 90° tab

## JUMPERS:

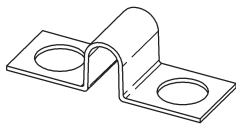

Pole to Pole

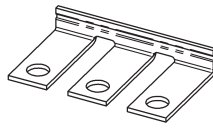

RJ

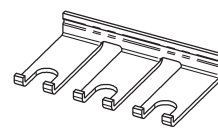

RJS

## SCREW & STUD OPTIONS:

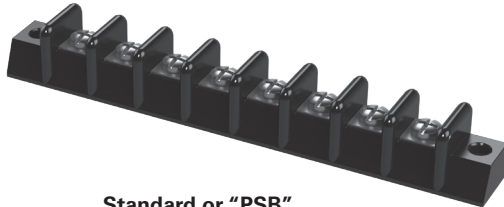

Standard or "PSB"



Stud Options

## SOLDER COMPONENTS - FEED-THRU AND OVER THE SIDE:



"ST"



"3/4 ST"

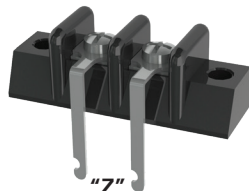

"Z"



"1921"



"2204"

## MARKING STRIPS:

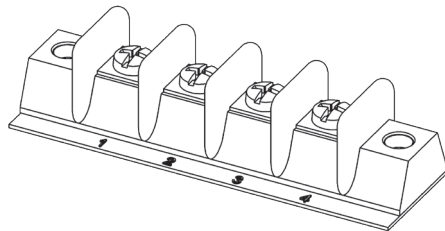



# MILITARY CLASS

## ELECTRICAL:

Amps & volts - see table

## STANDARDS:

Compliant to the A-A-59125

A-A-59125 superseded MIL-T-55164-C in 1997

These terminal blocks are constructed to meet both standards.

RoHS compliant (All)

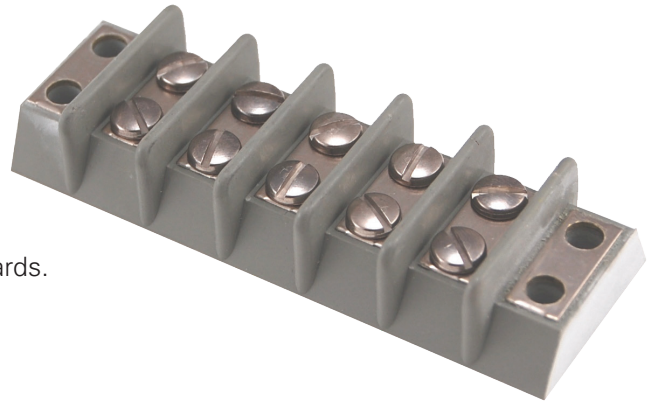

39TB05F

## WEBSITE RESOURCES:

Detailed product data sheets

- Material information
- Termination & mounting specifications

Dimensional drawings & 3D CAD files

Accessories available

A-A-59125/ MIL-T-55164 INFORMATION		TERMINAL TYPE	VOLTAGE		AMPS	WIRE & LUG INFORMATION				
CLASS	SPEC #	DESCRIPTION	MAX RATED	DIELECTRIC WITH TEST	MAX RATED	SCREW SIZE	RECMD MAX WIRE SIZE	MS17143 LUG #	MAX LUG WIDTH	RECMD TORQUE Lb-In (N-M)
37 TB	/ 1	Double Screw	300 V RMS	3000 V RMS	15 Amp 60 Hz	#6	#16 AWG	-11	0.282" [7.2]	8-10 [0.9-1.1]
38 TB	/ 2	Double Screw	600 V RMS	3400 V RMS	20 Amp 60 Hz	#6	#14 AWG	-14	0.31" [7.9]	8-10 [0.9-1.1]
39 TB	/ 3	Double Screw	600 V RMS	4000 V RMS	30 Amp 60 Hz	#8	#10 AWG	-9	0.41" [10.4]	10-12 [1.1-1.4]
40 TB	/ 4	Single Screw Feed Thru	300 V RMS	3000 V RMS	7.5 Amp 60 Hz	#6	#18 AWG	-10	0.282" [7.2]	8-10 [0.9-1.1]
41 TB	/ 5	Single Screw Feed Thru	600 V RMS	3400 V RMS	10 Amp 60 Hz	#6	#16 AWG	-14	0.31" [7.9]	8-10 [0.9-1.1]
42 TB	/ 6	Single Screw Feed Thru	600 V RMS	4000 V RMS	15 Amp 60 Hz	#8	#14 AWG	-8	0.41" [10.4]	10-12 [1.1-1.4]

# NAVY CLASS

## ELECTRICAL:

Amps & volts - see table

## STANDARDS:

Compliant to the A-A-59125

A-A-59125 superseded MIL-T-55164-C in 1997.

These terminal blocks are constructed to meet both standards.

RoHS compliant (All)

## WEBSITE RESOURCES:

Detailed product data sheets

- Material information
- Termination & mounting specifications

Dimensional drawings & 3D CAD files

Accessories available

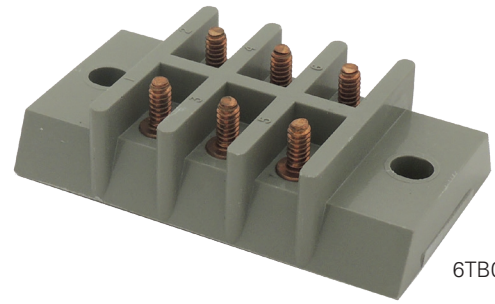

6TB06F

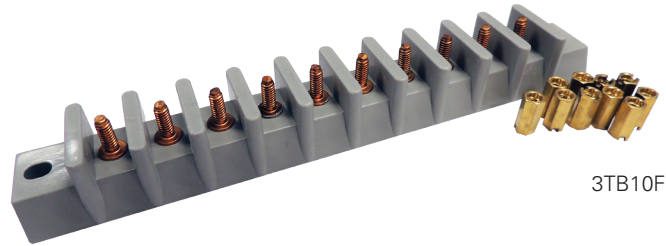

3TB10F

A-A-59125/ MIL-T-55164 INFORMATION		TERMINAL TYPE	VOLTAGE		AMPS	WIRE & LUG INFORMATION				
CLASS	SPEC #	DESCRIPTION	MAX RATED	DIELECTRIC WITH TEST	MAX RATED	SCREW SIZE	RECMD MAX WIRE SIZE	MS17143 LUG #	MAX LUG WIDTH	RECMD TORQUE Lb-In (N-M)
3TB	/ 9	Single Stud Single Row	600V RMS	2000V RMS	45 Amp 60 Hz	#8	#10 AWG	-3	0.395" [10.0]	16-18 [1.8-2.0]
4 TB	/ 10	Single Stud Double Row	600 V RMS	2200 V RMS	40 Amp 60 Hz	#8	#12 AWG	-3	0.395" [10.0]	16-18 [1.8-2.0]
5 TB	/ 11	Feed Thru Stud Single Row	600 V RMS	2200 V RMS	50 Amp 60 Hz	#8	#10 AWG	-3	0.395" [10.0]	16-18 [1.8-2.0]
6 TB	/ 12	Single Stud Double Row	600 V RMS	2200 V RMS	30 Amp 60 Hz	#6	#14 AWG	-5	0.307" [7.8]	10-12 [1.1-1.4]
7 TB	/ 13	Feed Thru Stud Single Row	600 V RMS	2200 V RMS	40 Amp 60 Hz	#6	#12 AWG	-6	0.307" [7.8]	10-12 [1.1-1.4]
8 TB	/ 14	Double Stud Double Row	300 V RMS	1500 V RMS	30 Amp 60 Hz	#5	#14 AWG	-11	0.282" [7.2]	8-10 [0.9-1.1]
9 TB	/ 15	Single Stud Single Row	300 V RMS	1500 V RMS	35 Amp 60 Hz	#6	#12 AWG	—	0.307" [7.8]	10-12 [1.1-1.4]
10 TB	/ 16	Single Stud Double Row	600 V RMS	2200 V RMS	30 Amp 60 Hz	#6	#14 AWG	—	0.242" [6.11]	10-12 [1.1-1.4]
11 TB	/ 17	Feed Thru Stud Single Row	600 V RMS	2200 V RMS	40 Amp 60 Hz	#6	#12 AWG	-15	0.242" [6.1]	10-12 [1.1-1.4]
15 TB	/ 19	Single Stud Double Row	600 V RMS	2200 V RMS	30 Amp 60 Hz	#8	#14 AWG	-8	0.307" [7.8]	16-18 [1.8-2.0]
16 TB	/ 20	Single Stud Double Row	1000 V RMS	3000 V RMS	40 Amp 60 Hz	#8	#12 AWG	-3	0.395" [10.0]	16-18 [1.8-2.0]
17 TB	/ 21	Double Stud Double Row	600 V RMS	2200 V RMS	40 Amp 60 Hz	#6	#12 AWG	-3	0.395" [10.0]	10-12 [1.1-1.4]
25 TB	/ 23	Single Stud Single Row	300 V RMS	1500 V RMS	25 Amp 60 Hz	#4	#14 AWG	-17	0.242" [6.1]	6-8 [0.7-0.9]
26 TB	/ 24	Double Stud Double Row	300 V RMS	1500 V RMS	20 Amp 60 Hz	#4	#16 AWG	-20	0.242" [6.1]	6-8 [0.7-0.9]

# SECTIONAL TERMINAL BLOCKS

## DIN (EURO-STYLE) SECTIONAL TERMINAL BLOCKS

### ELECTRICAL:

Insulating material:

- Nylon- 6/6, grey
- UL 94V-2 flammability rating
- 100° C / 212° F continuous, 170° C / 338° F intermittent & short exposure

Connector - copper, nickel plated

Screws - steel, zinc plated

Integrated pressure plate to avoid wire damage

For identification labels - see page 42

### STANDARDS:

UL recognized file no. XCFR2.E62806

CSA certified file no. LR700930

VDE

CE compliant

RoHS compliant

CATALOG #	WIRE RANGE	AMPS			VOLTS	DIMENSIONS (MM)			TERMINALS PER FOOT	TERMINAL TORQUE	DESCRIPTION
		UL	CSA	VDE		T	W	H			
MIK3	#12-#22 AWG	20	25	26	600	5	42	36	60	5	Terminal
MIK5	#10-#22 AWG	30	25	24	600	6	42	38	50	9 - 13.3	Terminal
MIK10	#8-#22 AWG	50	50	61	600	8	42	44	38	9.8	Terminal
MIK16	#6-#22 AWG	65	68	82	600	10	42	44	30	18	Terminal
MIK25	#4-#8 AWG	85	70	108	600	12	50	48	25	27	Terminal
MIKTS4	#12-#22 AWG	20	20	16	300	6	42	53	50	-	Disconnect
MIKSI5	#10-#20 AWG	10	-	6	300	8	60	47	38	-	Fused Terminal <sup>1</sup>
MIKE4	#10-#22 AWG	-	-	-	-	7	56	38	-	8.0	Grounding Lug <sup>2</sup>
MIKE10	#8 AWG	-	-	-	-	8	56	44	-	13.3	Grounding Lug <sup>2</sup>
MIKE16	#6 AWG	-	-	-	-	10	56	44	-	18	Grounding Lug <sup>2</sup>

<sup>1</sup> UL File No. E35113, For Fuse Type - 5x20 or 5x25 mm

<sup>2</sup> Grounding Lugs are Green/Yellow Nylon

Dimensions:  
H = Height  
W = Width  
T = Thickness

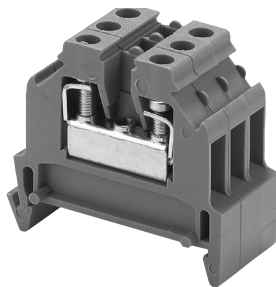
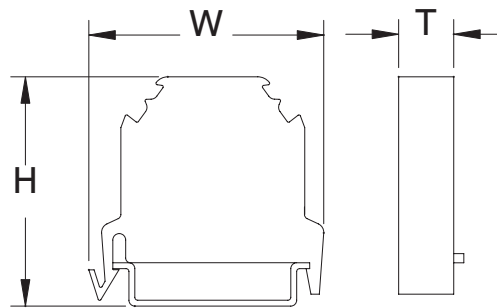

Terminal  
(MIK5)

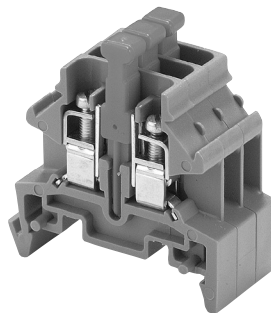

Disconnect Terminal  
(MIKTS4)

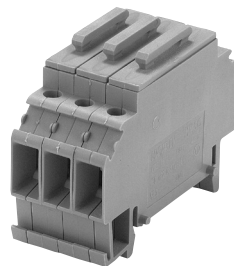

Fused Terminal  
(MIKSI5)

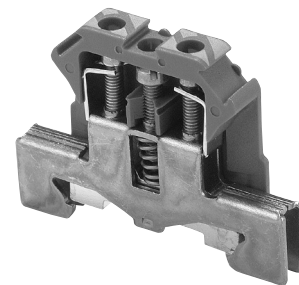

Grounding Lug  
(MIKE10)

# SECTIONAL TERMINAL BLOCKS

## DIN (EURO-STYLE) SECTIONAL TERMINAL BLOCKS HARDWARE

**Insulating end sections** - cover the last terminal of an assembly

**Insulating partitions** - for visual and electrical separation of terminals grouped on DIN rail

**2-position jumpers** - connect two adjacent terminals (middle portion snaps off to assemble)

**12-position jumpers** - connect up to 12 adjacent terminals (middle portion snaps off to assemble); jumper can be easily cut to length to connect smaller assemblies

**Connecting strap** - for linking two adjacent 12-pole jumpers

**Safety cover** - cover with warning label for line terminals which cannot be disconnected

**End brackets** - anchor on both ends of terminal assemblies to hold the assembly in place

**DIN rail** - standard 35 x 7.5 mm DIN rail, cut in 2 meter lengths with slots for mounting (steel, zinc plated)

	MIK3	MIK5	MIK10	MIK16	MIK25	MIKTS4	MIKS15
Insulating End Sections	MIW2	MIW4	MIW16	MIW16	MIW50	MIW4	-
Insulating Partitions	MIW4	MIW16	MIW50	MIW50	MIW70	-	MIW50
2-Position Jumper	MVB2-2	MVB4-2	MVB6-2	MVB16-2	MVB25	-	-
12-Position Jumper	MVB2-12	MVB4-12	MVB6-12	MVB16-12	-	-	-
Connecting Strap	MVL2-2	MVL4-2	MVL6-2	MVL16-2	MVL25	-	-
Safety Cover	MKAW2	MKAW2	MKAW10	MKAW16	MKAW25	-	-
End Bracket/Anchor <sup>1</sup>	MSK35	MSK35	MSK35	MSK35	MSK35	MSK35	MSK35
DIN Rail	MN35-2	MN35-2	MN35-2	MN35-2	MN35-2	MN35-2	MN35-2

<sup>1</sup>MSK35 - End Bracket Securing Torque 7-9 lb-in (.8-1 N-m)

## UNIVERSAL IDENTIFICATION LABELS TYPE MSH SPECIFICATIONS:

Available plain, with numbers, letters or symbols

Can be labeled vertically or horizontally

Single label MSH 5 can be used for all sizes

MSH5 & MSH6 are sold in ten strips of ten

MSH8 & MSH10 are sold in ten strips of five

RoHS compliant

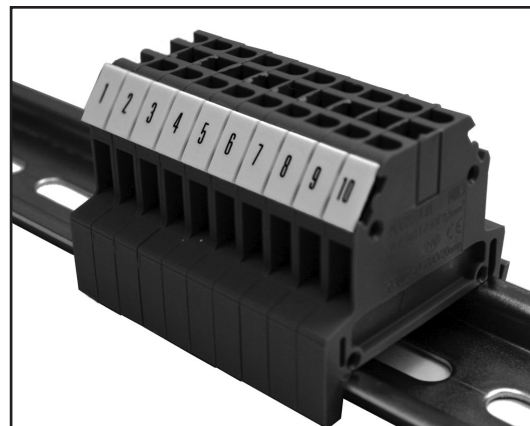

## ORDERING CODE:

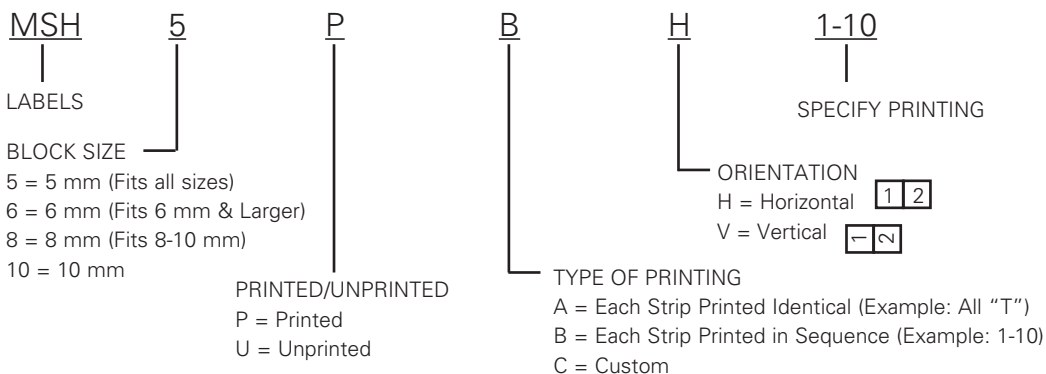



# SECTIONAL TERMINAL BLOCKS

## 3/8" SECTIONAL CHANNEL (C), FLAT (F), & DIN MOUNT

### ELECTRICAL:

See table

### STANDARDS:

UL recognized file no. XCFR2.E62806 or E47811  
 CSA certified file no. LR19766 (CSA C22-2 No. 158)  
 CE (Component IEC 60947-7-1)  
 RoHS compliant (All)

### WEBSITE RESOURCES:

Dimensional drawings & 3D CAD files  
 Termination and mounting specifications  
 Detailed product/series data sheets

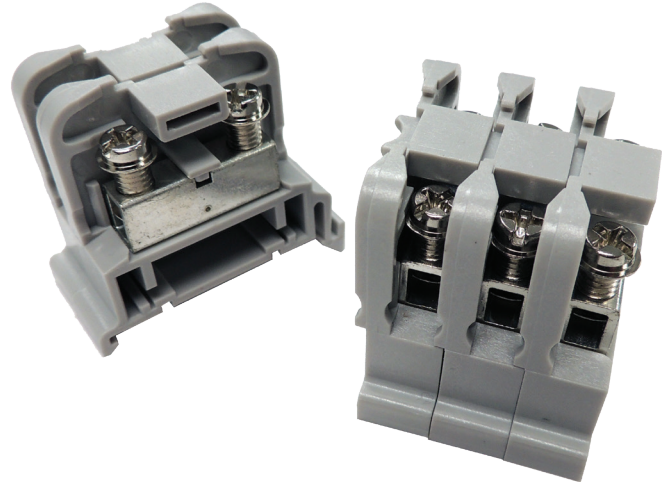

6G38 TSKK DIN

### 6G38 TS - TUBULAR SCREW CONNECTOR

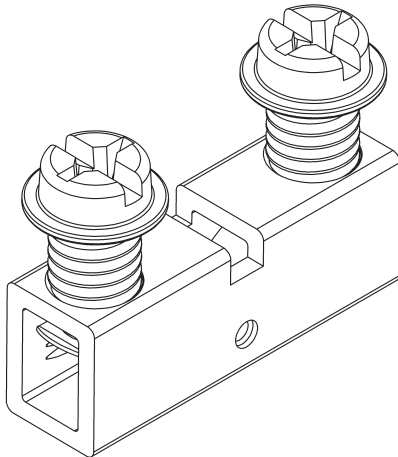

### ELECTRICAL AND WIRE RANGE INFO:

50 amps (40 amps CSA)  
 32 circuits per foot  
 Single and multiple wire combinations:

<u>Stranded CU</u>	<u>Solid CU</u>
(1) #8 - #18 AWG	(1) #10 - #16 AWG
(1-3) #12 AWG	(1-3) #12 AWG
(1-4) #14 AWG	(1-4) #14 or #16 AWG

CATALOG #	DESCRIPTION	STD PK
6G38 TS F	Flat mount block	100
6G38 TS C	Channel mount block	100
6G38 TS DIN	DIN mount block	25

### 6G38 TSKK - TS WITH WIRE PROTECTOR CONNECTOR

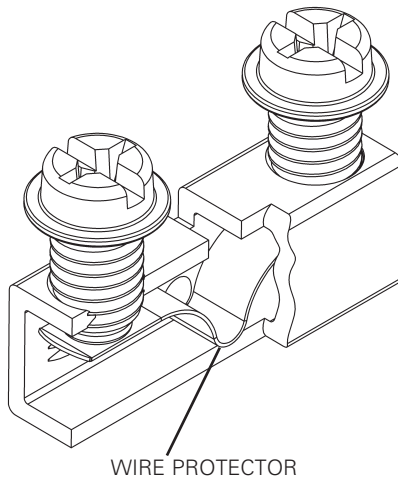

### ELECTRICAL AND WIRE RANGE INFO:

40 amps  
 32 circuits per foot  
 Single and multiple wire combinations:

<u>Stranded CU</u>	<u>Solid CU</u>
(1) #10 - #22 AWG	(1) #10 - #14 AWG
(1-2) #12 AWG	(1-2) #12 or #14 AWG
(1-3) #14 AWG	
(1-4) #16 AWG	
(1-5) #18 or #22 AWG	

CATALOG #	DESCRIPTION	STD PK
6G38 TSKK F	Flat mount block	100
6G38 TSKK C	Channel mount block	100
6G38 TSKK DIN	DIN mount block	25

# SECTIONAL TERMINAL BLOCKS

## ACCESSORIES:

CATALOG #	DESCRIPTION	IMAGE	STD PACK
J 38	Jumper for TS and TSKK		50
MC	Mounting Clamp (For channel style only)		25
MS 2	Vinyl Marking Strip (1/2" x 2' white)		25
MN35-2	DIN Rail, 35 x 7.5 mm 2 m long, slotted		25
MSK35	End bracket for DIN mount base		25
6G38 E C 6G38 E F 6G38 E DIN	End bracket for 6G38 versions		25
MPC-3 (3 ft channel) MPC-6 (6 ft channel)	Channel		1

## DIMENSIONS - 6G38 TS & TSKK

### CHANNEL MOUNT

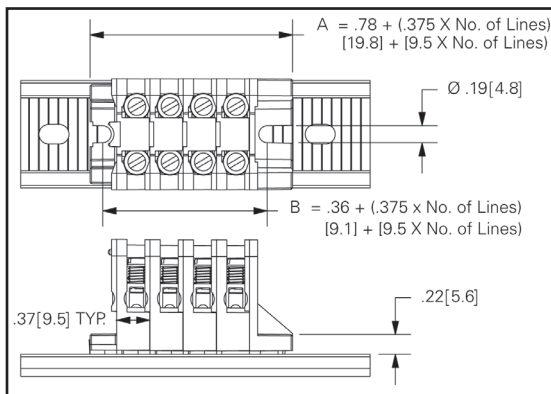

### FLAT MOUNT

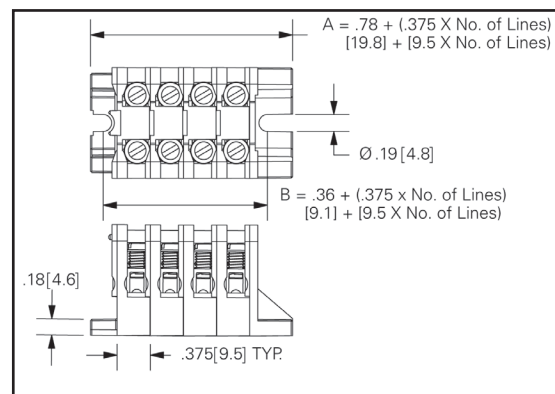

### DIN MOUNT

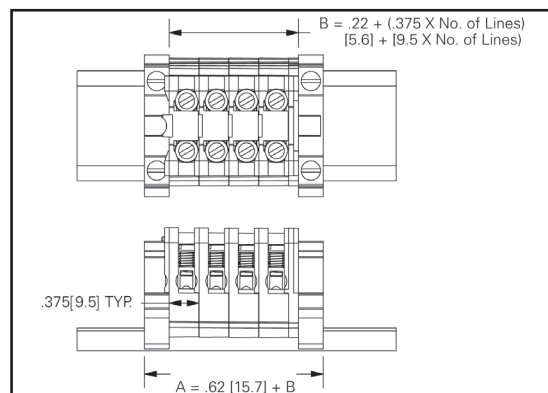

# SECTIONAL TERMINAL BLOCKS

## 1/2" SECTIONAL TERMINAL BLOCK

### ELECTRICAL:

70 amps, 600 volts  
 10 kA SCCR  
 24 circuits per foot  
 Bare wire range #4 - #16 AWG Copper

### STANDARDS:

UL recognized file no. XCFR2.E62806  
 CSA certified file no. LR19766  
 CE compliant  
 RoHS compliant





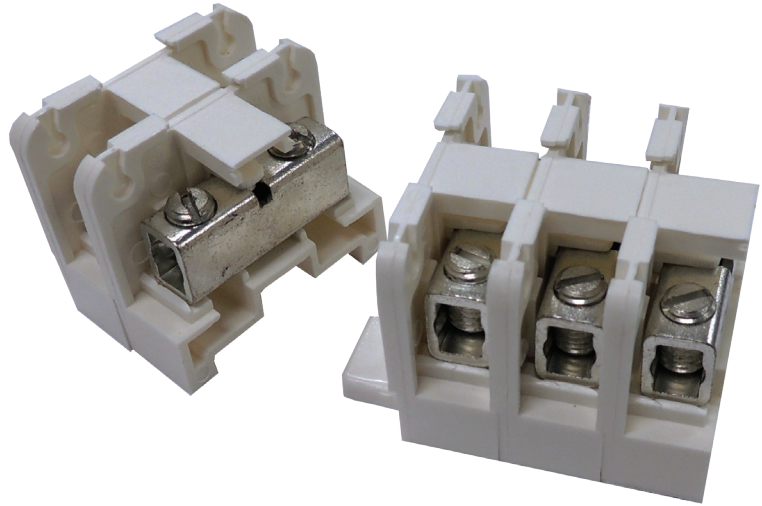

### WEBSITE RESOURCES:

Dimensional drawings & 3D CAD files  
 Termination and mounting specifications  
 Detailed product/series data sheets

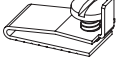

6H12 TSCU F

### ACCESSORIES:

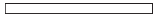
CATALOG #	DESCRIPTION	IMAGE	STD PK
6H12 TSCU F For flat mount block	Tubular Screw		50
6H12 TSCU C For channel mount block	Tubular Screw		50
6H12 E F For flat mount block	End Section		25
6H12 E C For channel mount block	End Section		25
J 12	Jumper		50
MC	Mounting Clamp		25
MPC-3 (3 ft channel) MPC-6 (6 ft channel)	Channel		--
MS 2	Vinyl Marking Strip - 1/2" x 2'		25

# FUSE HOLDER TYPES

Regal's Marathon® Special Products provide many NEMA®/barrier style fuse holders with different terminal options for the majority of North American fuses and several enclosed (European/IEC) styles.

CLASS	PAGE #	STYLES	APPLICATIONS	AMP/VOLT RANGE	WITHSTAND/SCCR
CC Class	44	Barrier Enclosed	For branch and small motor protection where high current limitation is required.	30-60 A 600 V	200,000
Fused Disconnect Switch	45	Disconnect	UL98 load breaking disconnect switch.	30 A 120-600 V	200,000
G Class	46	Barrier, Open	For use in branch circuits where higher performance and lower power levels are needed.	15-30 A 480-600 V	100,000
General Purpose (Semi-Cond.)	47	Stud, Stud / Terminal	Recognized holders for fuses with bolt down mounting such as semi-conductor, high-speed or industrial types (Classes J, T & L).	100-1200 A 1000 V	See Data Sheets
H Class	49	Barrier Panel-Board	For protection where frequent outages are common and there are low levels of available fault current.	30-600 A 250-600 V	10,000
J Class	50	Barrier, Open Enclosed	For maximum protection of motors, controllers or panels.	30-600 A 250-600 V	200,000
Midget (10x38)	52	See Website	For branch circuits in more general applications where current limitation requirements are lower.	30-60 A 600 V	See Data Sheets
Photovoltaic	See Website	Enclosed	For protection in solar power generation systems.	Up to 30A 1000 V	30,000
R Class	53	Barrier	For higher levels of protection at the same size of the H Class, where higher levels of fault current potential exist.	30-600 A 250-600 V	200,000
T Class	54	Barrier, Open	For a high degree of protection in situations where space is limited.	30-800 A 300-600 V	200,000
Accessories	55	Covers, DIN Rail Adapters	H, R, J, CC & M styles.	N/A	N/A

## WEBSITE RESOURCES:

- Dimensional drawings & 3D CAD files
- Termination and mounting specifications
- Detailed product/series data sheets
- Check distributor stock
- Request samples

NEMA is a trademark of National Electrical Manufacturers Association. All Rights Reserved.

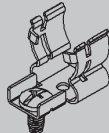
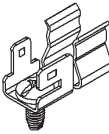
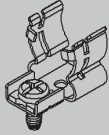
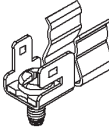
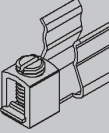

# WIRE CONNECTOR STYLES

HARDWARE OPTIONS		DESCRIPTION	ILLUSTRATION
S	Screw	Standard screw fastener primarily for ring/spade/fork terminals or small bare wire.	
SQ	Screw with Quick Connects	Screw terminal with additional 1/4" male quick-connect options.	
SP	SEMS Pressure Connector	Screw with a captive washer to provide more contact area for larger bare wire termination.	
SPQ	SEMS Pressure Connector with Quick Connects	SP option with additional 1/4" male quick-connect options.	
B	Box (or Compression) Terminals	Box connectors are ideal for large bare wire (up to 60A) termination.	

## CATALOG NUMBER NOMENCLATURE:

Excludes panel boards, enclosed and general purpose / recognized types.



- CC = C CLASS
- F = H CLASS (barrier style)
- G = G CLASS
- J = J CLASS
- M = 10 X 38 (misc or midget)
- R = R CLASS
- T = T CLASS

R = Indicates a reinforcing member is present (on 30-60 amp models only)  
 BLANK = a reinforcing member is not needed or has been removed per custom application specifications

# CLASS CC

## ELECTRICAL:

30/60 amps, 600 volts  
 200,000 amp withstand  
 For use with UL Class CC fuses only  
 Blown fuse indication available (6SC30AxI-C)

## STANDARDS:

UL recognized file no. IZLT2.E35113  
 CSA certified file no. LR21455  
 CE compliant  
 Touchsafe design (IP20) per IEC60529 (enclosed only)  
 RoHS compliant

## WEBSITE RESOURCES:

Dimensional drawings & 3D CAD files  
 Termination and mounting specifications  
 Detailed product data sheets



6SC30AI C

## ENCLOSED

AMPS	CATALOG # (REPLACE "x" WITH # OF POLES)	POLES (x)	BASE MATERIALS	WIRE RANGE
30	6SC30Ax C	1/2/3/4	Thermoplastic	1) #6 - #18 CU Stranded 1-2) #10 - #18 CU Stranded
30	6SC30AxI C	1/2/3/4	Thermoplastic	1) #10 - #18 Solid

EFK-MCKK - Pin kit (used for ganging multiple poles) - includes 10 handle pins and 20 body clips, use one handle pin and two body clips per pole

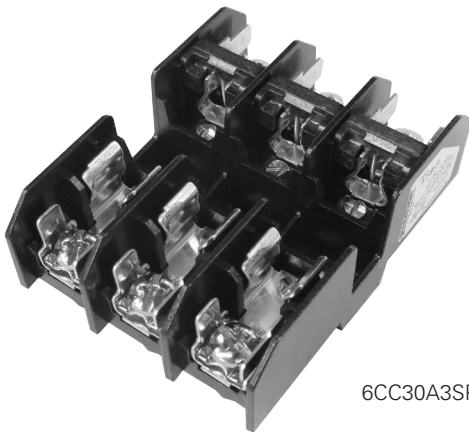

6CC30A3SPQ



6CC30A3B

## BARRIER

AMPS	CATALOG # (REPLACE "x" WITH # OF POLES)	POLES (x)	BASE MATERIALS	WIRE RANGE
30	6CC30AxSQ	1/2/3	Thermoplastic	#10 - #22 AWG CU
30	6CC30AxSPQ	1/2/3	Thermoplastic	#10 - #14 AWG CU
30	6CC30AxB	1/2/3	Thermoplastic	#6 - #14 AWG CU
30	6CC30AxBCU	1/2/3	Thermoplastic	#6 - #14 AWG CU
60	R6CC60AxB	1/2/3	Thermoplastic	#2 - #14 AWG CU #2 - #12 AWG AL

# FUSED DISCONNECT SWITCH

## ELECTRICAL:

30 amps

Volts - see table

Minimum indicator voltage - 90V AC

For use with UL Class CC fuses only

## STANDARDS:

cULus listed file no. WHTY.E483215

- UL98 - Open type switches
- CSA C22.2 No. 4 - enclosed and deadfront switches

IEC 60947-3

Touchsafe design (IP20) per IEC60529

RoHS compliant



FDS-30-C-2

## WEBSITE RESOURCES:

Dimensional drawings & 3D CAD files

Termination and mounting specifications

Detailed product data sheets

VOLTS	AMPS	CATALOG #	POLES (x)	WIRE TYPE	WIRE RANGE
120 AC / 125 DC	30	FDS-30-C-1	1	75° C CU Wire or Higher (CU75)	#4 - 18 AWG
600 AC	30	FDS-30-C-2	2	75° C CU Wire or Higher (CU75)	#4 - 18 AWG
600 AC	30	FDS-30-C-3	3	75° C CU Wire or Higher (CU75)	#4 - 18 AWG

# CLASS G

## ELECTRICAL:

15, 20 & 30 amps, 480 & 600 volts  
 100,000 amp withstand  
 For use with UL Class G fuses only

## STANDARDS:

UL recognized file no. IZLT2.E35113  
 CSA certified file no. LR21455  
 CE compliant  
 RoHS compliant

## WEBSITE RESOURCES:

Dimensional drawings & 3D CAD files  
 Termination and mounting specifications  
 Detailed product data sheets



RG30A3B



RG20A3SPQ

VOLTS	AMPS	CATALOG # (REPLACE "x" WITH # OF POLES)	POLES (x)	BASE MATERIALS	WIRE RANGE
480	30	RG30AxSQ	1/2/3	Thermoplastic	#10 - #22 AWG CU
	30	RG30AxSPQ	1/2/3	Thermoplastic	#10 - #14 AWG CU
	30	RG30AxB	1/2/3	Thermoplastic	#6 - #14 AWG CU
	30	RG30AxBCU	1/2/3	Thermoplastic	#6 - #14 AWG CU
600	15	RG15AxSQ	1/2/3	Thermoplastic	#10 - #22 AWG CU
	15	RG15AxSPQ	1/2/3	Thermoplastic	#10 - #14 AWG CU
	15	RG15AxB	1/2/3	Thermoplastic	#6 - #14 AWG CU
	15	RG15AxBCU	1/2/3	Thermoplastic	#6 - #14 AWG CU
	20	RG20AxSQ	1/2/3	Thermoplastic	#10 - #22 AWG CU
	20	RG20AxSPQ	1/2/3	Thermoplastic	#10 - #14 AWG CU
	20	RG20AxB	1/2/3	Thermoplastic	#6 - #14 AWG CU

See page 55 for available covers  
 See page 56 for DIN rail adapter



# GENERAL PURPOSE / MODULAR

## ELECTRICAL:

Up to 600 amps, 1500 volts AC/DC  
 SC withstand 200kA (600V), 10kA (1500V)

## STANDARDS:

UL Recognized fuse holder, evaluated to UL 4248-1,  
 file no. IZLT2.E35113  
 cURus - investigated to CSA C22.2 No 4248.1-07

## WEBSITE RESOURCES:

Dimensional drawings & 3D CAD files  
 Termination and mounting specifications  
 Detailed product data sheets

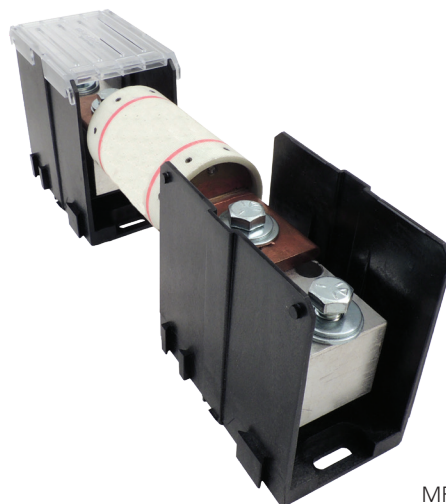

MFH SERIES

CATALOG # <sup>1</sup>	AMPS	VOLTS	COVER INCLUDED	FOR FUSE TYPES	FUSE TERMINAL	LINE SIDE TERMINAL	LOAD SIDE TERMINAL
MFH6153DD CH	600	1500	Yes	Specialty / Semi-conductor / High-speed	3/8" Tap	3/8" Tap	3/8" Tap
MFH6153DD	600	1500	No	Specialty / Semi-conductor / High-speed	3/8" Tap	3/8" Tap	3/8" Tap
MFH6063DD CH	600	600	Yes	J & T Class	3/8" Tap	3/8" Tap	3/8" Tap
MFH6063DD	600	600	No	J & T Class	3/8" Tap	3/8" Tap	3/8" Tap
MFH8155FF CH	800	1500	Yes	Specialty / Semi-conductor / High-speed	1/2" Tap	1/2" Tap	1/2" Tap
MFH8155FF	800	1500	No	Specialty / Semi-conductor / High-speed	1/2" Tap	1/2" Tap	1/2" Tap
MFH8065FF CH	800	600	Yes	J, T & L Class	1/2" Tap	1/2" Tap	1/2" Tap
MFH8065FF	800	600	No	J, T & L Class	1/2" Tap	1/2" Tap	1/2" Tap

<sup>1</sup>Each item provides one pair for one fuse

# GENERAL PURPOSE/SEMI CONDUCTOR

## ELECTRICAL:

See table

## STANDARDS:

UL recognized file no. IZLT2.E35113

RoHS compliant

## WEBSITE RESOURCES:

Dimensional drawings & 3D CAD files

Termination and mounting specifications

Detailed product data sheets

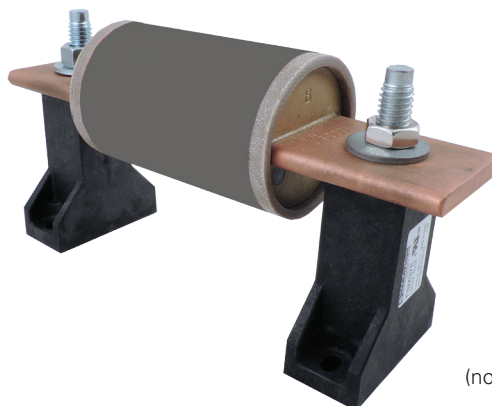

FSM37E  
with fuse  
(not included)

VOLTS	AMPS	CATALOG # <sup>1</sup>	STUD SIZES <sup>1</sup>	APPLICATION TORQUE	SC WITHSTAND RATING	MOUNTING
Up to 1000V AC/DC	400	FSM25E	1/4"-20 Stud	75 in-lbs	Approved for 200,000A; tested at 111 kA <sup>2</sup> s (I <sup>2</sup> t) and 20.0 kA (I <sub>p</sub> )	#10 fastener, torque to 25-30 in. lbs.
	800	FSM37E	3/8"-16 Stud	230 in-lbs	Approved for 200,000A; tested at 274 kA <sup>2</sup> s (I <sup>2</sup> t) and 26.2 kA (I <sub>p</sub> )	#10 fastener, torque to 25-30 in. lbs.
	1200	FSM50E	1/2"-13 Stud	300 in-lbs	Approved for 200,000A; tested at 465 kA <sup>2</sup> s (I <sup>2</sup> t) and 30.8 kA (I <sub>p</sub> )	1/4" fastener, torque to 25-30 in. lbs.

<sup>1</sup>Each item provides one unit

## ELECTRICAL:

Amps - see table

600 volts

## STANDARDS:

UL recognized file no. IZLT2.E35113

cUR file no. IZLT8.E35113

CE compliant

RoHS compliant

## WEBSITE RESOURCES:

Dimensional drawings & 3D CAD files

Termination and mounting specifications

Detailed product data sheets

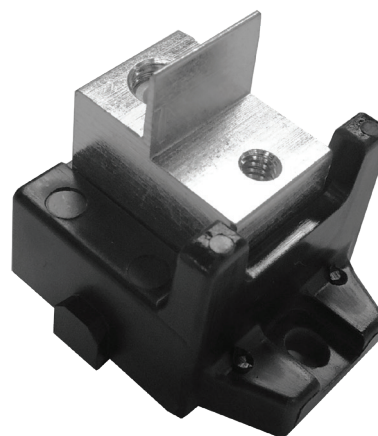

1MS101

VOLTS	MAX AMPS	CATALOG # <sup>1</sup>	WIRE RANGE	FASTENER SIZE	TESTED AT:	
					I <sup>2</sup> t	I <sub>p</sub>
600	100	1MS101	2/0 - #14	1/4 - 20	193kA	27.4kA
	400	1MS102	(2) 250 kcmil - #6	1/4 - 21	3480 kA	69.5 kA
	400	1MS103	(2) 250 kcmil - #6	3/8 - 16	3480 kA	69.5 kA
	600	1MS104	(2) 500 kcmil - #6	3/8 - 17	2840kA	50.8 kA

<sup>1</sup>Each item provides one unit

# CLASS H

## ELECTRICAL:

See table

## STANDARDS:

UL recognized file no. IZLT2.E35113

CSA certified file no. LR21455

CE compliant

RoHS compliant

## WEBSITE RESOURCES:

Dimensional drawings & 3D CAD files

Termination and mounting specifications

Detailed product data sheets

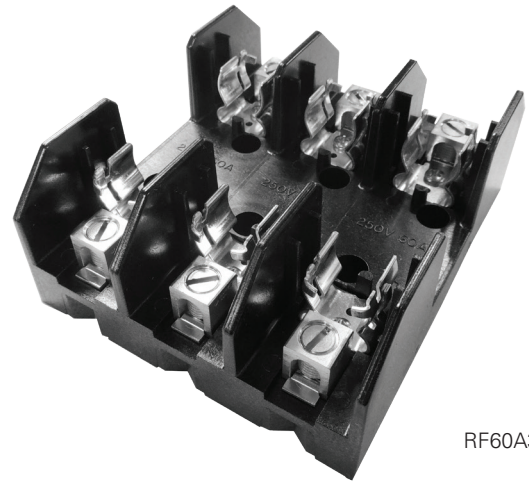

RF60A3B

VOLTS	AMPS	CATALOG # (REPLACE "X" WITH # OF POLES)	POLES (x)	BASE MATERIALS	WIRE RANGE
250	30	RF30AxS <sup>1</sup>	1/2/3	Thermoplastic	#10 - #22 AWG CU
	30	RF30AxSP <sup>1</sup>	1/2/3	Thermoplastic	#10 - #14 AWG CU
	30	RF30AxB <sup>1</sup>	1/2/3	Thermoplastic	#6 - #14 AWG CU
	60	RF60AxSQ <sup>2</sup>	1/2/3	Thermoplastic	#10 - #22 AWG CU
	60	RF60AxB	1/2/3	Thermoplastic	#2 - #14 AWG CU #2 - #12 AWG AL
	100	RF100AxB	1/2/3	Phenolic	2/0 - #14 AWG CU 2/0 - #12 AWG AL
	200	F200AxBE	1/3	Polyester	250 kcmil #6 AWG CU AL
	400	RF400AxB	1/3	Phenolic	(2) 350 kcmil 1/0 AWG CU AL
600	600	F600AxB	1/3	Phenolic	(2) 500 kcmil 1/0 AWG CU AL
	30	R6F30AxS <sup>1</sup>	1/2/3	Phenolic	#10 - #22 AWG CU
	30	R6F30AxSP <sup>1</sup>	1/2/3	Phenolic	#10 - #14 AWG CU
	30	R6F30AxB <sup>1</sup>	1/2/3	Phenolic	#6 - #14 AWG CU
	60	R6F60AxB <sup>1</sup>	1/2/3	Phenolic	#2 - #14 AWG CU #2 - #12 AWG AL
	100	R6F100AxB	1/2/3	Phenolic	2/0 - #14 AWG CU 2/0 - #12 AWG AL
	200	6F200AxBE	1/3	Polyester	250 kcmil #6 AWG CU AL
	400	R6F400AxB	1/3	Phenolic	(2) 350 kcmil 1/0 AWG CU AL
600	600	6F600AxB	1/3	Phenolic	(2) 500 kcmil 1/0 AWG CU AL

<sup>1</sup>For non-reinforced version, remove "R" in catalog number

<sup>2</sup>UL recognized file no. IZLT2.E35113

See page 55 for available covers

See page 56 for DIN rail adapter

Contact Customer Service for stud options

# CLASS J

## ELECTRICAL:

30 to 600 amps, 600 volts  
 200,000 amp withstand  
 For use with UL Class J fuses only

## STANDARDS:

UL recognized file no. IZLT.E35113  
 cULus (for Canada) file no. IZLT7.E35113  
 CE compliant  
 Touchsafe design (IP20) per IEC60529  
 RoHS compliant

## WEBSITE RESOURCES:

Dimensional drawings & 3D CAD files  
 Termination and mounting specifications  
 Detailed product data sheets



6SJ60AIC

## ENCLOSED

AMPS	CATALOG # (REPLACE "x" WITH # OF POLES)	POLES (x)	BASE MATERIALS	WIRE RANGE
30	6SJ30AxIC	1/2/3	Thermoplastic	#1 - #18 AWG (2) #10 - #12 AWG
60	6SJ60AxIC	1/2/3	Thermoplastic	#1 - #14 AWG (2) #6 - #14 AWG



6SJ60AIC (2 pole)

FUSE HOLDERS

# CLASS J

## ELECTRICAL:

30 to 600 amps, 600 volts  
 200,000 amp withstand  
 For use with UL Class J fuses only

## STANDARDS:

UL recognized file no. IZLT.E35113  
 CSA certified file no. LR21455  
 CE compliant  
 Touchsafe design (IP20) per IEC60529  
 RoHS compliant

## WEBSITE RESOURCES:

Dimensional drawings & 3D CAD files  
 Termination and mounting specifications  
 Detailed product data sheets

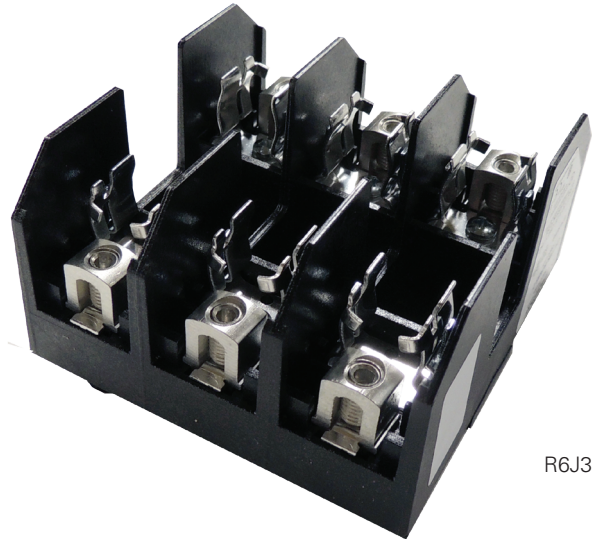

R6J30A3B

## BARRIER

AMPS	CATALOG # (REPLACE "x" WITH # OF POLES)	POLES (x) (E=EXPANDER)	BASE MATERIALS	WIRE RANGE
30	R6J30AxS <sup>1</sup>	1/2/3/E	Thermoplastic	#10 - #22 AWG CU
30	R6J30AxSP <sup>1</sup>	1/2/3/E	Thermoplastic	#10 - #14 AWG CU
30	R6J30AxB <sup>1</sup>	1/2/3/E	Thermoplastic	#6 - #14 AWG CU
60	R6J60AxB <sup>1</sup>	1/2/3	Thermoplastic	#2 - #14 AWG CU AL
100	R6J100AxB	1	Thermoplastic	2/0 - #14 AWG CU 2/0 - #12 AWG AL
100	R6J100AxB	3	Phenolic	2/0 - #14 AWG CU 2/0 - #12 AWG AL
200	6J200AxBFBD	1/3	Phenolic	250 kcmil #6 AWG CU AL
400	6J400AxBFBD	1/3	Phenolic	(1) 600 - #2 kcmil (1) 350 - #6 AWG CU AL
400	MFH6063DD	1	Thermoplastic	3/8" Tap & Fastener
600	MFH8065FF	1	Thermoplastic	1/2" Tap & Fastener

<sup>1</sup> For non-reinforced version, remove "R" in catalog number

See page 55 for available covers  
 See page 56 for DIN rail adapter  
 Contact Customer Service for stud options  
 Fuse mounting hardware supplied with fuse holder



6J200A3BFBD



# MIDGET

## ELECTRICAL:

Amps & volts - see chart  
 For use with midget 10 x 38 mm fuses  
 Blown fuse indication available (6SM30AxI C only)

## STANDARDS:

UL recognized file no. IZLT2.E35113  
 CSA certified file no. LR21455  
 CE compliant  
 Touchsafe design (IP20) per IEC60529 (enclosed only)  
 RoHS compliant

## WEBSITE RESOURCES:

Dimensional drawings & 3D CAD files  
 Termination and mounting specifications  
 Detailed product data sheets



6SM30AI C

## ENCLOSED

AMPS	VOLTAGE	AMP WITHSTAND	CATALOG # (REPLACE "x" WITH # OF POLES)	POLES (x)	BASE MATERIAL	WIRE RANGE
30	1000	200,000	6SM30AX C	1/2/3/4	Thermoplastic	(1) #6 - #18 CU Stranded
30	600	200,000	6SM30AXI C	1/2/3/4	Thermoplastic	(1) #10 - #18 Solid (2) #10 - #18 Stranded

EFK-MCKK - Pin kit (used for ganging multiple poles) - includes 10 handle pins and 20 body clips, use one handle pin and two body clips per pole.



6M30A3BCU



6M30A3SPQ

## BARRIER

AMPS	VOLTAGE	AMP WITHSTAND	CATALOG # (REPLACE "x" WITH # OF POLES)	POLES (x)	BASE MATERIAL	WIRE RANGE
30	600	100,000	6M30AxSQ	1/2/3	Thermoplastic	#10 - #22 AWG CU
30	600	100,000	6M30AxSPQ	1/2/3	Thermoplastic	#10 - #14 AWG CU
30	600	100,000	6M30AxB	1/2/3	Thermoplastic	#6 - #14 AWG CU
30	600	100,000	6M30AxBCU	1/2/3	Thermoplastic	#6 - #14 AWG CU

See page 55 for available covers  
 See page 56 for DIN Rail Adapter

# CLASS R

## ELECTRICAL:

30 to 600 amps, 250 & 600 volts  
 200,000 amp withstand  
 For use with UL Class R fuses only

## STANDARDS:

UL recognized file no. IZLT2.E35113  
 CSA certified file no. LR21455  
 CE compliant  
 RoHS compliant

## WEBSITE RESOURCES:

Dimensional drawings & 3D CAD files  
 Termination and mounting specifications  
 Detailed product data sheets

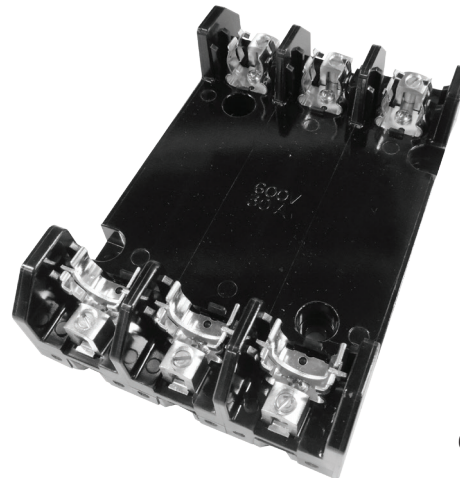

6R30A3B

VOLTAGE	AMPS	CATALOG # (REPLACE "x" WITH # OF POLES)	POLES (x)	BASE MATERIALS	WIRE RANGE
250	30	R30AxS	1/2/3	Thermoplastic	#10 - #22 AWG CU
	30	R30AxSP	1/2/3	Thermoplastic	#10 - #14 AWG CU
	30	R30AxB	1/2/3	Thermoplastic	#6 - #14 AWG CU
	60	R60AxB	1/2/3	Thermoplastic	#2 - #14 AWG CU #2 - #12 AWG AL
	100	R100AxB	1/2/3	Phenolic	2/0 - #14 AWG CU 2/0 - #12 AWG AL
	200	R200AxBE	1/3	Polyester	250 kcmil #6 AWG CU AL
	400	R400AxB	1/3	Phenolic	(2) 350 kcmil - 1/0 AWG CU AL
600	30	6R30AxS	1/2/3	Phenolic	#10 - #22 AWG CU
	30	6R30AxSP	1/2/3	Phenolic	#10 - #14 AWG CU
	30	6R30AxB	1/2/3	Phenolic	#6 - #14 AWG CU
	60	6R60AxB	1/2/3	Phenolic	#2 - #14 AWG CU #2 - #12 AWG AL
	100	6R100AxB	1/2/3	Phenolic	2/0 - #14 AWG CU 2/0 - #12 AWG AL
	200	6R200AxBE	1/3	Polyester	250 kcmil #6 AWG CU AL
	400	6R400AxB	1/3	Phenolic	(2) 350 kcmil 1/0 AWG CU AL

See page 55 for available covers  
 See page 56 for DIN rail adapter  
 Contact Customer Service for stud options  
 Fuse mounting hardware supplied with fuse holder

# CLASS T

## ELECTRICAL:

30 to 800 amps, 300 & 600 volts  
 200,000 amp withstand  
 For use with UL Class T fuses only

## STANDARDS:

UL recognized file no. IZLT2.E35113  
 CSA certified file no. LR21455  
 CE compliant  
 RoHS compliant

## WEBSITE RESOURCES:

Dimensional drawings & 3D CAD files  
 Termination and mounting specifications  
 Detailed product data sheets  
 Accessories available

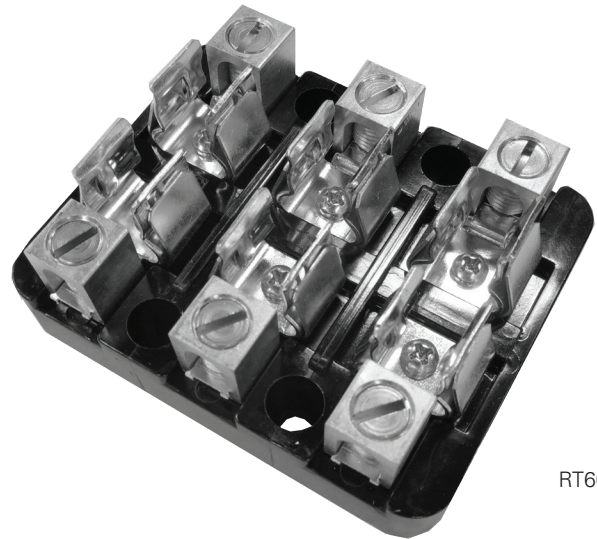

RT60A3B

VOLTS	AMPS	CATALOG # (REPLACE "x" WITH # OF POLES)	POLES (x)	BASE MATERIALS	WIRE RANGE
300	30	RT30AxB	2/3	Phenolic	#2 - #14 AWG CU #2 - #12 AWG AL
	60	RT60AxB	2/3	Phenolic	#2 - #14 AWG CU #2 - #12 AWG AL
	100	T100AxB	1/3	Phenolic	2/0 - #14 AWG CU 2/0 - #12 AWG AL
	200	T200AxB	1/3	Phenolic	250 kcmil #6 AWG CU AL
	400	T400AxB	1/3	Phenolic	(2) 250 kcmil #6 AWG CU AL
	600	T600AxB	1	Phenolic	(2) 500 kcmil #6 AWG CU AL
600	30	R6T30AxS	2/3	Phenolic	#10 - #22 AWG CU
	30	R6T30AxSP	2/3	Phenolic	#10 - #14 AWG CU
	30	R6T30AxB	2/3	Phenolic	#2 - #14 AWG CU #2 - #12 AWG AL
	60	R6T60AxB	2/3	Phenolic	#2 - #14 AWG CU #2 - #12 AWG AL
	100	6T100AxB	1/3	Phenolic	2/0 - #14 AWG CU 2/0 - #12 AWG AL
	200	6T200AxB	1/3	Phenolic	250 kcmil #6 AWG CU AL
	400	6T400AxB	1	Phenolic	(2) 250 kcmil #6 AWG CU AL
	600	6T600AxB	1	Phenolic	(2) 500 kcmil #6 AWG CU AL
	800	MFH8065DD	1	Thermoplastic	1/2" Tap & Fastener

# COVERS & PULLERS

## COVERS:

UL listed accessories under file no. JDVS2.E181825

Opening allows view of self-indicating fuses

Holes for test probes and re-tightening of wire terminations

Provides IP20 (touchsafe) protection per IEC 60529 (30A & 60A models)

RoHS compliant

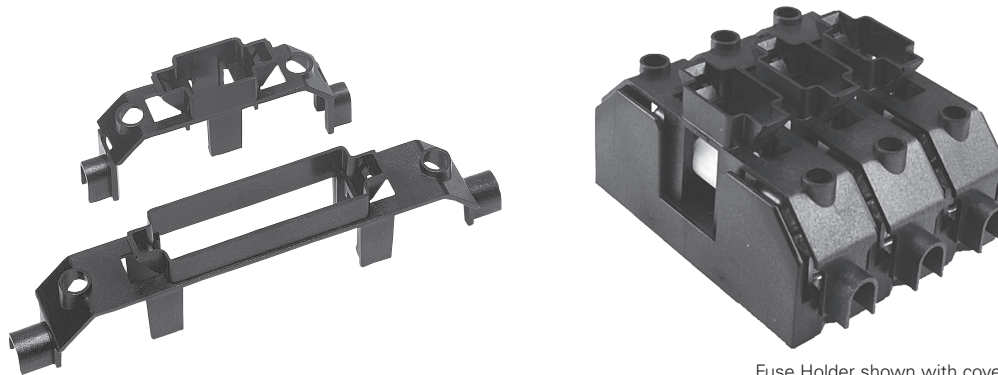

Fuse Holder shown with covers attached

FUSE TYPE	AMPS	VOLTAGE	CATALOG #	FOR USE WITH FUSE HOLDER #	IP20 (FINGER SAFE)*
H/R	30	250	CHR230	F30A / R30A	Yes
H/R	60	250	CHR260	F60A / R60A	Yes
H/R	100	250	CHR2100	RF100A / R100A	Yes
H/R	30	600	CHR630	6F30A / 6R30A	Yes
H/R	60	600	CHR660	6F60A / 6R60A	Yes
H/R	100	600	CHR6100	R6F100A / 6R100A	Yes
J	30	600	CJ630	6J30A	Yes
J	60	600	CJ660	6J60A	Yes
J	100	600	CJ6100-1C	R6J100A	No
J	100	600	CJ6100-2C	R6J100A	No
J	100	600	CJ6100-3C	R6J100A	No
CC, G	30	600	CC630	6CC30A	Yes
CD	60	600	CC660	R6CC60A	Yes
MISC	30	600	CCM630**	6M30A / 6CCM30A	Yes

\*Applications involving fuse holders other than Marathon may not provide IP20 finger protection

\*\*Covers are recognized if used with recognized fuses

## COVER-PULLER (CATALOG # CVR-MCC):

For use with

- Class CC (30 amp)
- Midget , 10 x 38 (30 amp)
- Class G (15 & 20 amp only)

Provides IP20 (touchsafe) protection per IEC 60529 (30A & 60A models)

RoHS compliant

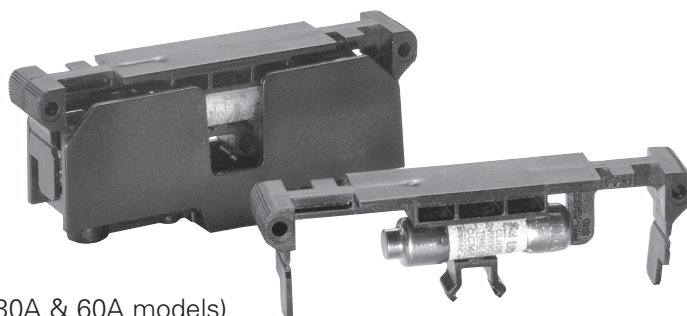

# DIN RAIL ADAPTERS

## DIN RAIL ADAPTERS:

Secures product on DIN rail  
 Wide end use temperature range  
 RoHS compliant

COMPATIBLE PRODUCTS	PART #	DIN R 1	DIN R 2
TERMINAL BLOCKS	985 Series	✓	
	1100 Series	✓	
	1200 Series	✓	
	1500 Series	✓	
	1600 Series	✓	
FUSE HOLDERS	2 & 3 Pole Class H	✓	
	2 & 3 Pole Class R	✓	
	Class CC		✓
	Midget		✓
	Class G		✓

USE A #8 SELF TAPPING SCREW FOR MOUNTING COMPONENT



### DIN R 1 ASSEMBLY METHOD:

Press adapter onto rail, fasten component with #8 self tapping screw (screw not supplied).

Assembly locks firmly on to DIN rail.

### DIN R 2 ASSEMBLY METHOD:

DIN R 2 snaps securely to the Marathon® fuse holders and to DIN rails without tools, which permits the fuse holders to be mounted directly to standard and low profile 35mm symmetrical and 32mm asymmetrical DIN rails.

May be removed by lifting the disconnect tab.

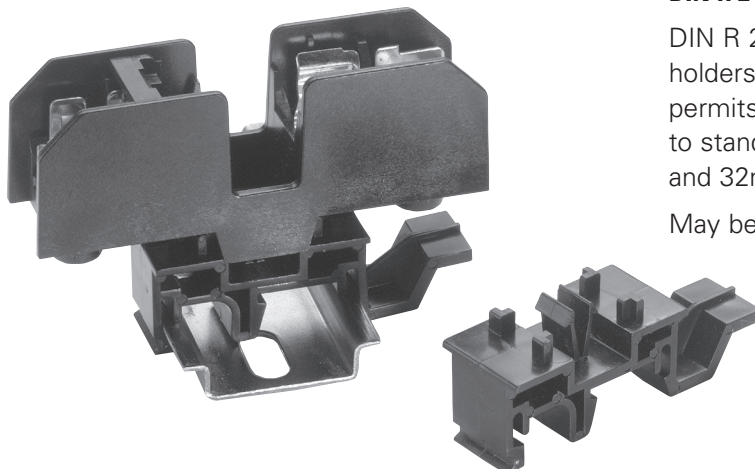



# Terms & Conditions of Sale

ALL QUOTATIONS ARE OFFERED AND ALL PURCHASE ORDERS ARE ACCEPTED BY SELLER SUBJECT ONLY TO THESE TERMS AND CONDITIONS.

## 1. DEFINITIONS:

"Buyer" means the entity to which Seller is selling Products or Services under a Contract.

"Contract" means the agreement between Buyer and Seller governing the sale of Products and/or Services by Seller to Buyer. These Terms and Conditions, the Quotation (if one is issued by Seller), any purchase order acknowledgement (if one is issued by Seller), and Buyer's purchase order (except to the extent that it conflicts with these Terms and Conditions, the Quotation, and/or the order acknowledgement) constitute the Contract.

"Products" means the equipment, parts, materials, supplies, and other goods that Seller has agreed to supply under the Contract. References in these Terms and Conditions to the purchase and sale of Products may mean, where applicable, the licensing of Software loaded on or provided with the Products.

"Quotation" means Seller's statement identifying the Products and Services, together with any quantity, price, delivery schedule, and/or other terms and conditions (in addition to or different from these Terms and Conditions), offered by Seller for sale to Buyer. A Quotation that incorporates these Terms and Conditions by reference shall be deemed to include these Terms and Conditions, whether or not Seller provides a complete copy of these Terms and Conditions to Buyer with the Quotation, with a purchase order acknowledgement, or with an invoice. Where there is a conflict between these Terms and Conditions and other provisions of the Quotation, the latter shall control.

"Services" means the services that Seller has agreed to provide under the Contract.

"Software" means software loaded on or provided with the Products.

"Seller" means the Regal entity – whether Regal Beloit Corporation ("RBC") or an RBC subsidiary – supplying Products and/or providing Services under the Contract.

"Terms and Conditions" means these "Terms and Conditions of Sale."

2. **CONTRACT FORMATION:** No agreement or understanding, oral or written, purporting to modify these Terms and Conditions shall be binding on Seller unless it is made in writing, specifically stating that it is a modification of these Terms and Conditions and it is signed by Seller's authorized representative. No course of dealing, usage of trade, or course of performance shall be relevant to explain or supplement any of these Terms and Conditions. If these Terms and Conditions are deemed an offer, Buyer's acceptance of Seller's offer is expressly limited to acceptance of these Terms and Conditions. Fulfillment of Buyer's order does not constitute acceptance of any of Buyer's terms and conditions and does not modify or amend these Terms and Conditions. Buyer's purchase order for the purchase of Products and/or for the performance of Services shall constitute Buyer's assent to these Terms and Conditions. Any terms and conditions contained in Buyer's purchase order or other form of communication from Buyer that are additional to or different from these Terms and Conditions, shall be deemed rejected by Seller, unless expressly accepted in writing by Seller's authorized representative. Alternatively, if these Terms and Conditions are deemed to be a response to, an acceptance of, or a written confirmation of, Buyer's offer, whether provided in the form of a purchase order or otherwise, Seller's acceptance is expressly conditioned upon Buyer's assent to these Terms and Conditions. Buyer's acceptance of Products tendered to Buyer by Seller shall constitute Buyer's express assent to all of the terms and conditions contained in these Terms and Conditions. All proposals, negotiations and representations, if any, made prior to or with reference hereto are hereby superseded by these Terms and Conditions. References in this Section to "these Terms and Conditions" shall be deemed to mean these Terms and Conditions and Seller's Quotation, if Seller has issued a Quotation.

3. **ACCEPTANCE OF PURCHASE ORDERS:** No Buyer purchase order shall be binding on Seller until accepted in writing by Seller, and Seller shall have no liability to Buyer with respect to purchase orders that are not accepted. Shipment against a purchase order shall be deemed to constitute Seller's acceptance thereof, subject to these Terms and Conditions. All purchase orders shall be subject to these Terms and Conditions, whether or not the purchase orders so state. Purchase orders accepted by Seller may not be cancelled or modified by Buyer without the prior written consent of Seller.

4. **QUOTATIONS:** Quotations shall expire and shall be void thirty (30) days from date of the Quotation, unless otherwise specified in the Quotation. The Quotation may be modified or withdrawn by Seller at any time before Seller's receipt of Buyer's conforming acceptance.

5. **PRICES; PRICE CHANGES:** (a) Products. The price of the Products sold pursuant to the Contract shall be as set forth in the Quotation. If price is not specified in the Quotation, price shall be based upon Seller's prices in effect at the time of shipment. Published prices are for Products of Seller's current standard design and constructed of standard materials. Variation from the standard design and/or materials requires special pricing. Seller reserves the right at any time, and without incurring any obligation, to discontinue the manufacture of any model, to withdraw products from sale, to make changes in design and/or to add improvements to products. Price also shall be based on freight rates in effect at the time of shipment. Where applicable, in the event of an increase in the applicable freight rates before the shipment of Products, such changes will be for the account of Buyer. Price advances, discounts, extras and other terms and conditions are subject to change without notice. Unless otherwise provided in the Quotation, price is based on delivery in accordance with the "Delivery" section below. Prices include Seller's standard packing. (b) Services. Services prices are based on normal business hours (8 AM to 5 PM Monday through Friday). Overtime and Saturday hours will be billed at one and one half (1.5) times the normal business hour hourly rate. Sunday hours will be billed at two (2) times the normal business hours hourly rate; holiday hours will be billed at three (3) times the normal business hours hourly rate.

6. **TAXES, DUTIES AND FEES:** Seller shall be responsible for taxes measured on Seller's net income based upon performance of, or payment for, work under the Contract ("Seller Taxes"). Buyer shall be responsible for all other taxes, duties, fees or other charges of any kind (including, but not limited to any manufacturer's tax, retailer's occupation tax, use tax, sales tax, excise tax, duty, custom, inspection or testing fee, value added tax, or any other tax, fee or charge of any nature whatsoever) imposed by any governmental authority against Buyer, Seller or Seller's suppliers and/or contractors, based upon the Contract between Seller and Buyer. In the event Seller is required to pay any such tax, fee or charge, regardless whether such tax, fee or charge is imposed before or after Seller's delivery of the Products and/or Buyer's payment under the Contract, Buyer shall reimburse Seller therefor. In lieu of such reimbursement, Buyer shall provide Seller, at the time the order is submitted, with an exemption certificate or other document acceptable to the authority imposing such tax, fee or charge. If Seller's prices include any taxes, duties or

fees (other than Seller Taxes), any change in such taxes, duties and/or fees shall be the basis for a price adjustment.

7. **TERMS OF PAYMENT:** (a) Terms. Terms of payment are cash in full, without set-off or discount, in U.S. dollars, and by wire transfer, no later than thirty (30) days from date of invoice. (b) Payment Default. If Buyer defaults in any payment when due, or in the event that any voluntary or involuntary bankruptcy or insolvency proceedings involving Buyer are initiated by or against Buyer, then the whole Contract price shall immediately become due and payable upon demand, or Seller, at its option and without prejudice to its other lawful remedies, may defer delivery or cancel the Contract. Where delivery is deferred and Seller does not demand immediate payment of the full Contract price, pro-rata payments shall become due as shipments are made. (c) Buyer Financial Condition. If, during the period of performance of the Contract, the financial condition of Buyer is determined by Seller not to justify the terms of payment specified, Seller may demand full or partial payment in advance before proceeding with the work, or satisfactory security or guarantees that invoices will be promptly paid when due, or, at its option, without prejudice to other lawful remedies, may defer delivery or cancel the Contract. (d) Delay. If delivery is delayed by Buyer, which delay must be consented to by Seller, Seller may store the Products in accordance with subsection 8(e) "Storage" below and Seller may submit a new estimate of cost for completion based on prevailing conditions. Payments shall become due from the date on which Seller is prepared to deliver the Products and storage shall be the Buyer's risk and expense as provided in subsection 8(g) "Storage" below. If manufacture is delayed by Buyer for any cause, a partial payment based upon the proportion of the order completed shall become due from the date on which Seller is notified of the delay. (e) Late Payment Charge. Buyer shall pay a late payment charge on all amounts not paid in full when due at the rate of one and one half percent (1.5%) per month or at the maximum legal permissible rate, whichever is lower. (f) Exceptions. Supplement A to these Terms and Conditions lists Seller business units for which payment terms vary from payment terms set forth in this Section 7.

## 8. DELIVERY; TITLE TRANSFER; RISK OF LOSS/DAMAGE:

(a) Delivery – U.S. Buyer. For sales in the U.S. that do not involve export from the U.S., Seller shall deliver Products to Buyer EXW Seller's U.S. point of shipment (Incoterms® 2010). The point of shipment shall be the shipping dock of Seller's factory, warehouse or other facility that Seller designates as its discretion as point of shipment from time to time.

(b) Sales Involving Exports from U.S.

(1) Delivery – U.S. Buyer; Subsequent Drop Shipment to Location Outside U.S. For sales, in the U.S. to a U.S. Buyer, which involve drop shipment at Buyer's request and/or on Buyer's behalf, to a location outside the U.S., Seller shall deliver the Products to Buyer EXW Seller's U.S. point of shipment (Incoterms® 2010). The point of shipment shall be the shipping dock of Seller's factory, warehouse or other facility that Seller designates at its discretion as its point of shipment from time to time. Buyer is responsible for all transportation charges incurred after delivery of the Products to the carrier or Buyer at the point of shipment and shall reimburse Seller for any transit insurance or freight pre-paid for the Products by Seller. Buyer shall bear the risk of loss and/or damage in transportation. Buyer is responsible for filing any export documents required for export from the U.S.

(2) Delivery – Non-U.S. Buyer; Routed Export Transactions. For sales outside the U.S. to a U.S. Buyer, Seller shall deliver Products to Buyer's freight forwarder EXW Seller's U.S. point of shipment (Incoterms® 2010). The point of shipment shall be the shipping dock of Seller's factory, warehouse or other facility that Seller designates at its discretion as its point of shipment from time to time. In a "Routed Export Transaction," as defined in the U.S. Census regulations, 15 CFR Section 301.10, the U.S. entity, Buyer shall authorize Buyer's designated freight forwarder or Seller to facilitate the export of the Products from the U.S. and to prepare and file export documentation with respect to such export transaction (hereafter, to "Facilitate the Export"). If Buyer authorizes its designated freight forwarder to Facilitate the Export, Buyer's freight forwarder shall provide Seller with a copy of the final export documentation and proof of filing. If Buyer authorizes Seller to Facilitate the Export, Buyer shall cause Buyer's freight forwarder to provide Seller the information needed by Seller to Facilitate the Export. Buyer shall give timely notice to Seller identifying whom it has designated to Facilitate the Export.

(c) Delivery Dates. Delivery dates are approximate, are not guaranteed and are based upon prompt receipt by Seller from Buyer of all necessary shipping and other information. Seller may deliver in advance of the delivery schedule. Seller reserves the right to make delivery in installments, with all installments to be separately invoiced and paid for by Buyer when the Products are delivered, except that, for Routed Exports, delivery of the Products to a commercial carrier at the shipping point shall constitute delivery to Buyer.

(d) Title Transfer. Title to Products shall pass to Buyer upon the earlier of delivery of the Products to the carrier or Buyer at the point of shipment in accordance with the U.S. Census regulations, 15 CFR Section 301.10, for Routed Export Transactions, title shall transfer to Buyer upon delivery to Buyer's designated freight forwarder. Subject to applicable law, Seller, upon notice to Buyer, may retain title to the Products until such time as Seller receives payment in full from Buyer. Title to Software shall not pass to Buyer and is subject to the applicable license.

(e) Risk of Loss/Damage. Risk of loss and/or damage shall pass to Buyer upon delivery in accordance with subsection (a) above, except that, for Routed Export Transactions, risk of loss and/or damage shall pass upon delivery of the Products to Buyer's designated freight forwarder.

(f) Delivery by Seller's Carrier. Where the parties agree that delivery shall be made at a location other than Seller's point of shipment, where Seller will deliver using its carrier or Seller's privately owned or leased trucks, unloading at the agreed location shall constitute delivery to Buyer. Freight and handling charges by Seller may not reflect actual freight charges prepaid to the carrier by Seller due to incentive discounts earned by Seller based upon Seller's aggregate volume of freight tendered to a carrier or when a carrier must be used which charges a rate which is different than the rate upon which Seller's freight and handling charges were based. When shipments are delivered in Seller's privately owned or leased trucks, Buyer will be charged an amount approximating the prevailing common carrier rate.

(g) Storage. In the event that Buyer is unable to accept delivery of the Products at time of shipment, Seller shall invoice Buyer for the full purchase price as if shipment had been made and: (i) if Seller is able to store such Products in its own facilities, Buyer will pay Seller the reasonable handling and storage charges for the period of such storage, or (ii) if Seller is unable to store such goods at its own facility, Seller reserves the right to arrange handling and storage in a suitable bonded warehouse for Buyer at Buyer's expense. In cases where handling and storage become necessary, it shall be Buyer's responsibility to modify the program or to make arrangements for shipment at Buyer's expense.

## 9. EXCUSABLE DELAYS; FORCE MAJEURE:

(a) Excuse of Performance. Seller shall not be liable for any ordinary, incidental, or consequential loss or damage as a result of Seller's delay in or failure of delivery, or installation of Products or performance of Services due to (i) any cause beyond Seller's reasonable control, (ii) an act of God, act of Buyer, embargo or other government act, authority, regulation or request, fire, theft, accident, strike, slowdown or other labor disturbance, war, armed conflict, act or threat of terrorism, riot, epidemic, delay in transportation, or (iii) inability to obtain necessary labor, materials, components, or facilities. Should any of the aforementioned events occur, Seller, at its option, may cancel Buyer's order with respect to any undelivered Products or incomplete Services or extend the delivery date for a period equal to the time lost because of delay. Notice of such election shall be given promptly to Buyer. In the event Seller elects to so cancel the Contract, Seller shall be released of and from all liability for failure to deliver the Products or to perform the Services, including, but not limited to, any and all claims on behalf of Buyer for lost profits, or any other claim of any nature which Buyer might have. If shipping or progress of the work is delayed or interrupted by Buyer, directly or indirectly, Buyer shall pay Seller for all additional charges resulting therefrom.

(b) Allocation. If Seller determines that its ability to meet the demand for products, including the Products, or to obtain labor, materials, components or facilities is hindered, limited or made impracticable due to causes set forth in subsection (a) above, Seller may allocate its available supply of Products, including the Products, among its purchasers on such basis as Seller determines to be equitable without liability for any failure of performance which may result therefrom.

## 10. LIMITED WARRANTY.

(a) Scope and Period.

(1) Products. Seller warrants that the Products shall be delivered free from defects in material, workmanship and title and shall conform to Seller's specification agreed upon in a written and signed agreement by Buyer and Seller, if applicable, for the Products. This warranty shall expire twelve (12) months from first use of the Product or eighteen (18) months from date of manufacture of the Product, whichever occurs first.

(2) Repaired and/or Replaced Products and/or Parts of Products. Seller warrants that the repaired or replaced Products or parts of Products shall be delivered free from defects in material, workmanship and title. In the case of repaired or replaced Products or parts of Products comprising warranty remedies for Products, this warranty shall expire upon expiration of the warranty period applicable to the Products originally supplied by Seller. In the case of other repaired or replaced parts of Products, this warranty shall expire twelve (12) months from the date of repair or manufacture of the Products or parts of the Products.

(3) Services. Seller warrants that the Services shall be performed in a competent and diligent manner in accordance with any mutually agreed specification. This warranty shall expire ninety (90) days from the date of completion of such Services.

(4) Software. Seller warrants that the Software shall execute, at time of delivery, in accordance with the specification agreed upon in a written and signed agreement by Buyer (as licensee) and Seller (as licensor) when properly installed on the Products. This warranty shall expire six (6) months from date of manufacture of the first Product in which the Software is loaded.

(5) Applicability. This warranty shall apply to any Products and/or Software bought, acquired, and/or used by an entity that, when it purchases the Products or other facility that Seller designates as a "Transferee", except that any claim made against Seller pursuant to this warranty shall be made by Buyer only. Seller shall not be bound by this Section 10 to satisfy a claim under this Section made against Seller by a Transferee, whether such Transferee is a direct or indirect Transferee of Buyer. Buyer shall provide any Transferee of a Product or Software written conspicuous notice of Sections 10 and 11 hereof.

(6) Exceptions. Supplement B to these Terms and Conditions lists Seller Products, parts, Services and Software for which Seller's warranties vary from the warranties set forth in this subsection 10(a).

(b) Remedies.

(1) Products. If, prior to expiration of the warranty period set forth in subsection 10(a)(1) above, any Products shall be proved to Seller's satisfaction to be defective or nonconforming with the warranty set forth therein, Seller will repair or replace such defective Products or components at Seller's factory, warehouse or other facility that Seller designates at its discretion as point of shipment from time to time (Incoterms® 2010), or will refund or provide Buyer with a credit in the amount of the purchase price paid therefor by Buyer, at Seller's sole option. Buyer's exclusive remedy and Seller's sole obligation under this warranty shall be limited to such repair or replacement, FCA factory, warehouse or other facility that Seller designates at its discretion as point of shipment from time to time (Incoterms® 2010), or refund or credit by Seller, and shall be conditioned upon Seller's receiving written notice of any defect and/or nonconformance within a reasonable period of time, but in no event more than thirty (30) days, after it was discovered or by reasonable care should have been discovered. All claims not made in writing and received by Seller within such thirty (30) day period shall be deemed waived. In no event shall Seller's liability for such defective or nonconforming Products exceed the purchase price paid by Buyer for such Products. With prior approval from Seller, Buyer shall return the alleged defective Product or part, freight prepaid, for Seller's inspection, and no other Products shall be returned to any Seller office, factory, warehouse, authorized service center or other facility, without Seller's written consent.

(2) Repaired and/or Replacement Products and/or Parts of Products. If prior to the expiration of the applicable warranty period set forth in subsection 10(a)(2) above, any replacement Products and/or parts of Products shall be proved to Seller's satisfaction to be defective or nonconforming with the warranty set forth therein, the remedy set forth in subsection 10(b)(1) above shall apply to such replacement Products and/or parts of Products.

(3) Services. If, prior to expiration of the warranty period set forth in subsection 10(a)(3) above, any Services shall be proved to Seller's satisfaction to be nonconforming with the warranty set forth therein, Seller will re-perform such nonconforming Services. If the Services cannot be re-performed, Seller, at its option, shall refund or credit monies paid by Buyer for such nonconforming Services.

(4) Software. If, prior to expiration of the warranty period set forth in subsection 10(a)(4) above, (i) Buyer provides, in writing, a complete description of the claimed nonconformance in the Software, and (ii) the Software is proven to Seller's satisfaction to be so nonconforming with the warranty set forth therein, Seller will correct the nonconformance by, at its option: (i) modifying or making available to Buyer instructions for modifying the program or (ii) making such nonconforming or (iii) making available a corrected or replacement program FCA Seller's factory, warehouse or other facility that Seller designates at its discretion as point of shipment from time to time (Incoterms® 2010).

# Terms & Conditions of Sale

(c) Exclusions - The warranties set forth in this Section 10 do not cover:

(1) shipping expenses to and from Seller's office, factory, warehouse, authorized service center or other location; Seller's cost for repair or replacement of defective Products or any tax, duty, custom, inspection or testing fee, or any other charge of any nature related thereto;

(2) costs of removing defective Products from, and/or disassembling, equipment in which Products are assembled or re-installing Products and/or reassembling such equipment, or testing repaired or replaced Products and/or the equipment;

(3) field service travel and living costs and expenses;

(4) Products subjected to abuse, neglect, negligence, misuse, misapplication, accident, damages by circumstances beyond Seller's control, improper installation (if by anyone other than Seller), improper operation (including, but not limited to, operation in excess of rated capacity or otherwise not in accordance with installation, maintenance, or operating instructions or requirements) improper maintenance, improper storage, and/or any other than normal use or service;

(5) Products maintained, serviced, repaired or altered by anyone other than Seller or Seller's authorized service agencies;

(6) Products and/or parts not manufactured by Seller; for Products furnished by Seller or purchased by others, Seller will assign to Buyer the written warranty, if any of the manufacturer, if assignment is reasonably practicable; however, Seller does not adopt or guarantee or represent that the manufacturer will comply with any of the terms of the warranty of such manufacturer, but, in no event shall Seller's obligations be greater than those provided under Seller's warranty set forth in this Section 10; and/or

(7) failures of the Software to be interruption-free or error-free or to meet Buyer's or any other party's requirements; and, problems caused by use of the Software in conjunction with third-party software, hardware, or products.

(d) **DISCLAIMER: THE FOREGOING WARRANTIES ARE IN LIEU OF ALL OTHER EXPRESS AND IMPLIED WARRANTIES, ARISING BY OPERATION OF LAW OR OTHERWISE, INCLUDING, WITHOUT LIMITATION, THE IMPLIED WARRANTIES OF MERCHANTABILITY AND FITNESS FOR A PARTICULAR PURPOSE, WHETHER OR NOT THE PURPOSE OR USE HAS BEEN DISCLOSED TO SELLER IN SPECIFICATIONS, DRAWINGS, OR OTHERWISE AND WHETHER OR NOT SELLER'S PRODUCTS ARE SPECIALLY DESIGNED AND/OR MANUFACTURED BY SELLER FOR BUYER'S USE OR PURPOSE. NO EMPLOYEE, REPRESENTATIVE, OR AGENT OF SELLER OTHER THAN AN OFFICER OF SELLER IS AUTHORIZED TO ALTER OR MODIFY ANY PROVISION OF THIS SECTION 10 OR TO MAKE ANY GUARANTEE, WARRANTY, OR REPRESENTATION, EXPRESS OR IMPLIED, ORALLY OR IN WRITING, WHICH IS CONTRARY TO THE FOREGOING.** Except where Buyer and Seller agree in a written and signed agreement upon the specifications applicable to the Products, Software, and/or Services, any description of the Products, Software, and/or Services, whether in writing or made orally by Seller or Seller's agents, specifications, samples, models, bulletins, drawings, diagrams, engineering sheets or similar materials used in connection with Buyer's order are for the sole purpose of identifying the Products and shall not be construed as an express or implied warranty. Any suggestions by Seller or Seller's agents regarding use, application or suitability of the Products, Software, and/or Services, express or implied warranty unless confirmed to be such in writing by Seller's authorized officer.

## 11. LIMITATIONS OF REMEDY AND LIABILITY:

(a) Breach of Warranty Claims. Buyer's only remedy for breach of any warranty under the Contract, other than the warranty provided under Section 13 "Intellectual Property Indemnity," shall be the applicable remedy set forth in Section 10 "Limited Warranty" above. Seller's total liability for any and all breach of warranty claims under the Contract shall not exceed the purchase price allocable to the Product, Software or Service or part thereof which gives rise to the claim.

(b) Other Claims. Seller's liability for any claim other than a breach of warranty claim under Section 10 "Limited Warranty," whether in contract, negligence, tort, strict liability, indemnity or otherwise for any loss or damage arising out of, connected with, or resulting from the Contract or the performance or breach thereof, or from the design, manufacture, sale, delivery, resale, repair, replacement, installation, technical direction of installation, inspection, operation or use of any Products covered by or furnished under the Contract or from Services rendered under the Contract, shall in no case (except as provided in Section 13 "Intellectual Property Indemnity") exceed five percent (5%) of the purchase price allocable to the Products or part thereof or Services giving rise to the claim.

(c) Consequential Damage Disclaimer. SELLER SHALL NOT BE LIABLE FOR AND DISCLAIMS ALL CONSEQUENTIAL, INCIDENTAL, CONTINGENT, SPECIAL OR PUNITIVE DAMAGES WHATSOEVER. Seller shall not be liable for any profits or revenues, loss of use of the Products, Software or any related equipment or systems, cost of capital, cost of substitute products, cost of facilities or services, business interruption, downtime, shutdown, or slowdown costs, any other types of economic loss, penalties, special or punitive damages, and claims of Buyer's customers for any such damages.

(d) Expiration of Claims. All claims against Seller arising out of or related to the Contract or the performance or breach thereof shall expire unless made and presented to Seller in writing by Buyer before expiration of the applicable warranty period.

(e) Precedence. The limitations of this Section shall apply regardless of whether a claim is based in contract, tort (including negligence), warranty, strict liability, intellectual property, or otherwise, and shall take precedence over any conflicting terms and conditions, except where the limitations of liability of such conflicting terms limit Seller's liability further.

## 12. INDEMNITY:

(a) Third party claims. Each of Buyer and Seller (each an "Indemnified Party" and an "Indemnifying Party") shall indemnify the other party from and against claims brought by a third party, for bodily injury or damage to the third party's tangible property, to the extent such injury and/or damage is caused by the negligence of the Indemnifying Party, provided that the Indemnified Party gives the Indemnifying Party prompt notice of any such claim and all necessary information and assistance so that the Indemnifying Party, at its option, may defend or settle such claim and the Indemnified Party does not take any adverse position in connection with such claim. In the event that the injury or damage is caused by joint or concurrent negligence of Buyer and Seller, the loss or expense shall be borne by each party in proportion to its degree of negligence. For purposes of Seller's indemnity obligations hereunder, Products shall not be considered third party property and the facility in which a Product or Software is used and/or the Services are performed shall not be considered third party property.

(b) Indemnity by Buyer for Third Party Warranty Claims. If Buyer supplies Products or Services to a third party, uses Products or Services

at a facility owned by a third party, and/or transfers Products and/or Software to a third party, Buyer shall indemnify and defend Seller from and against any and all claims by, and liability to, any such third party in connection with the limitations of this Section 12 "Limited Warranty" and 11 "Limitations of Remedy and Liabilities." For purposes of this subsection (b), "Seller" means Seller, its affiliates, suppliers, contractors, licensors and its employees.

## 13. INTELLECTUAL PROPERTY INDEMNITY:

Seller warrants that, to the best of its knowledge, Products, Services and/or Software furnished hereunder, and any part thereof, (each a "Delivered Item") shall be delivered free of any rightful claim of any third party not affiliated with Buyer for infringement of any U.S. patent, any trademark registered in the U.S. Patent and Trademark Office and/or any copyright registered in the U.S. Copyright Office. Seller will, at its own expense, defend or settle any suits that may be instituted against Buyer for alleged infringement by the Delivered Item of any U.S. patent, any trademark registered in the U.S. Patent and Trademark Office and/or any copyright registered in the U.S. Copyright Office provided that: (a) such alleged infringement consists of the use of the Delivered Item for (i) any of the purposes for which Buyer informed Seller such Delivered Items would be used, or (ii) if Buyer did not so inform Seller, any of the purposes for which Buyer reasonably believed such Delivered Items would be used; (b) Buyer shall have made all payments for such Delivered Items then due hereunder; (c) Buyer shall give Seller immediate notice in writing of any such suit and transmit to Seller immediately upon receipt of all processes and papers served upon Buyer; (d) Buyer does not take any position adverse to Seller in connection with such claim; and (e) Buyer shall permit Seller through Seller's counsel, either in the name of Buyer or in the name of Seller, to defend such suits) and give all needed information, assistance and authority to enable Seller to do so. In case of a final award of damages in any such suit, Seller will pay such award but will not be responsible for any compromise or settlement made without its written consent. In case the Delivered Item itself is in such suit held to infringe any valid patent issued in the United States and/or a trademark and/or copyright registered in the United States, and its use is enjoined, or in the event of a settlement or compromise approved by Seller which shall preclude future use of the Delivered Item, Seller shall, at its own expense, and at its sole option, either: (a) procure rights to continue using such Delivered Item; (b) modify the Delivered Item to render it non-infringing; (c) replace the Delivered Item with a non-infringing Product and/or Software; or (d) refund the purchase price paid by Buyer for the Delivered Item after return of the Delivered Item to Seller (less reasonable attorney's fees and costs). Notwithstanding the foregoing, Seller shall not be held responsible for claims of infringement of any patents covering the use of the Delivered Item in combination with other goods or materials not furnished by Seller. The foregoing states the entire liability of Seller for intellectual property infringement, and IN NO EVENT SHALL SELLER BE LIABLE FOR CONSEQUENTIAL OR INCIDENTAL DAMAGES ATTRIBUTABLE TO AN INTELLECTUAL PROPERTY INFRINGEMENT. Buyer, at its own expense, shall defend Seller against, and/or settle, (a) any patent, trademark, copyright or other intellectual property infringement claim pertaining to a Delivered Item furnished by Seller to Buyer manufactured in accordance with designs, drawings or other descriptions proposed or furnished by Buyer; and (b) any claim against Seller of contributory infringement resulting from the use or resale by Buyer of a Delivered Item sold hereunder. Buyer shall indemnify Seller for any award against Seller or settlement by Seller regarding any such claims and attorneys' fees and defense costs incurred in defense of such claims.

## 14. SOFTWARE LICENSE:

(a) License Grant: Seller grants Buyer a nonexclusive, royalty-free, perpetual, limited license to use the Software in the U.S. and solely in conjunction with (a) the operation of the Products purchased and sold under the Contract and/or other product meeting Seller's specifications; and (b) any other purpose agreed upon in a written and signed agreement between Buyer and Seller.

(b) Scope of License: Upon Seller's prior written approval, Buyer may make a reasonable number of copies of Software as necessary for backup, configuration, installation, and restoration of the Products. Also upon Seller's prior written approval, Buyer may authorize a third-party contractor or service provider to exercise these rights on Buyer's behalf and for Buyer's benefit. Buyer may transfer possession of Software and its media to another party only in conjunction with the transfer of the Products on which the Software is loaded and only upon agreement of the other party to the terms and conditions of the Contract. Upon such transfer, Buyer shall destroy all Buyer's copies of Software and related documentation. All licenses and grants pursuant to the Contract shall immediately terminate once Buyer no longer rightfully owns or possesses the Products. No other rights under this license are granted. Upon Seller's request, Buyer shall provide Seller with written notice of any such transfer providing the name, address, and contact information of the subsequent Buyer within 15 days of such transfer.

(c) Use Restrictions: Buyer shall not (a) copy, display, transfer, adapt, modify, or distribute in any form the Software except as set forth in the Contract or in Seller documentation provided by Seller to Buyer with the Software; (b) reverse engineer, disassemble, decompile, or otherwise translate the Software's object code, unless expressly permitted by applicable law without the possibility of contractual waiver; or (c) sublicense or lease the Software or any copy thereof except with the transfer of the Products on which the Software is loaded. Except as provided under the terms of Seller's standard escrow agreement between Seller and Buyer, if applicable, Buyer shall not make available to any party, without prior written consent from Seller or its authorized agent, source code for the Software. Buyer shall not, directly or indirectly, export or reexport, or knowingly permit the export or re-export of, the Products, or any technical information about the Products, to any country for which the United States Export Administration Act, any regulation thereunder, or any similar United States law or regulation, requires an export license or other United States Government approval, unless Buyer obtains the appropriate export license and obtains written approval from Seller.

(d) Maintenance and Support: Seller may offer to Buyer the option to purchase from Seller annual or bi-annual maintenance and support services under the terms and conditions of Seller's then-standard maintenance and support agreement. Buyer may renew this maintenance term at Seller's then-current maintenance rates. In the event Buyer purchases additional Software licenses, maintenance fees for such licenses shall be prorated to be coterminous with Buyer's existing maintenance period. In no event shall Seller be responsible for providing maintenance services for a period during which maintenance coverage is lapsed.

## 15. SECURITY AGREEMENT AND FINANCING STATEMENTS:

As security for payment of the purchase price under the Contract, Buyer hereby irrevocably grants Seller a security interest in the Products purchased by Buyer, together with all accessories, attachments and replacement parts and all substitutions, replacements and proceeds thereof to secure payment of the purchase price and of all monies which may be due under the Contract. Buyer hereby authorizes Seller to file all financing statements, any amendments and continuations thereof, or any other documents necessary or reasonably required, for the perfection and protection of a security interest under applicable law, and to deliver notice to prior holders of security inter-

ests, of Seller's security interest in the Products to protect its interest.

## 16. INSURANCE:

Until payment in full of the purchase price, Buyer shall maintain insurance covering all Products sold by Seller to Buyer in such amounts and against such risks as is customary by companies engaged in the same or similar business and similarly located, and shall, upon Seller's request, furnish evidence of such insurance satisfactory to Seller.

## 17. DRAWINGS; OTHER DESIGN DATA:

All specifications, drawings, designs, data, information, ideas, methods, product samples, tools, gages, dies, fixtures, patterns and/or inventions made, conceived, developed or acquired by Seller in connection with procuring and/or executing the Contract will vest in and inure to Seller's sole benefit notwithstanding any charges therefor which may have been or may be imposed by Seller on Buyer. Buyer shall not give, loan, exhibit, sell or transfer to any person who is not a Buyer employee and authorized to receive such information, or to any organization or entity any drawing, photograph, specification or product sample furnished by Seller or reproduction thereof which may enable such person, organization or entity to furnish similar products or parts therefor.

## 18. RETURN OF PRODUCTS:

No Product or part shall be returned to Seller without written authorization and shipping instructions first having been obtained from Seller.

## 19. ASSIGNMENT AND SUBCONTRACTING:

None of Buyer's rights under the Contract shall be assigned by Buyer to any other person, whether by operation of law or otherwise, without Seller's prior written approval. Seller may, without the necessity of obtaining Buyer's prior written consent, assign the Contract or subcontract the production of all or any portion of the Products and/or performance of the Services.

## 20. CANCELLATION:

No purchase order submitted to Seller may be cancelled by Buyer without the prior written consent of Seller, which consent will at all times be conditioned on Buyer's agreement to pay Seller's cancellation charge. For a finished Product that, in Seller's judgment, is readily resalable to others, the cancellation charge shall be 15% of the invoice price of the Product. For all other cancellations, the cancellation charge shall amount to all cost and expenses incurred by Seller and arising out of or in connection with Buyer's purchase order plus reasonable profit. In no event shall the cancellation charge be less than 10% of the invoice price of the Product or more than the invoice price.

21. HIGH RISK APPLICATION USE DISCLAIMER: PRODUCTS AND SERVICES SOLD BY SELLER ARE NOT INTENDED FOR USE IN CONNECTION WITH ANY NUCLEAR FACILITY OR ACTIVITY, CRITICAL SAFETY SYSTEM, MEDICAL DEVICE, MILITARY DEVICE, SATELLITE, AVIATION EQUIPMENT, AIR TRAFFIC CONTROL EQUIPMENT, OR OTHER HIGH RISK APPLICATIONS (COLLECTIVELY, "HIGH RISK APPLICATIONS"). SELLER SHALL NOT USE OR PERMIT OTHERS TO USE PRODUCTS OR SERVICES FOR SUCH HIGH RISK APPLICATIONS WITHOUT SELLER'S PRIOR WRITTEN CONSENT. IF SO USED WITHOUT SELLER'S PRIOR WRITTEN CONSENT, SELLER DISCLAIMS ALL LIABILITY FOR ANY DAMAGE, INJURY OR CONTAMINATION, AND BUYER SHALL INDEMNIFY AND HOLD SELLER, ITS OFFICERS, AGENTS, EMPLOYEES, SUCCESSORS, ASSIGNS AND CUSTOMERS HARMLESS FROM AND AGAINST ANY AND ALL SUCH LIABILITY. SELLER'S CONSENT, IF ANY, WILL BE CONDITIONED UPON ADDITIONAL TERMS AND CONDITIONS ACCEPTABLE TO SELLER.

## 22. GOVERNING LAW; VENUE:

These Terms and Conditions and the Contract shall be governed by and construed in accordance with the laws of the State of Wisconsin. Seller and Buyer irrevocably submit to the exclusive jurisdiction of the state courts located in Rock County, State of Wisconsin and the federal courts located in the State of Wisconsin, and Seller and Buyer waive any objection to venue or forum non conveniens, for the resolution of any dispute relating to these Terms and Conditions or the Contract. The rights and obligations of Seller and Buyer shall not be governed by the provisions of the United Nations Convention on Contracts for the Internal Sale of Goods.

## 23. EXPORT/IMPORT:

Buyer shall comply, in the receipt and use of the Products and the Software, with all applicable import and export control laws, regulations, orders and requirements of the jurisdictions in which the Seller and Buyer are established or from which Products and Software are provided. Buyer shall not transfer, release, import, or export Products and/or Software in violation of such applicable laws, regulations or other legal requirements. Buyer shall provide a completed end-user certification in a form satisfactory to Seller upon Seller's request.

## 24. ATTORNEYS' FEES:

Buyer agrees to pay all of Seller's costs and expenses of collection and related litigation, including but not limited to attorneys' fees and costs.

## 25. SALVATORY CLAUSE:

The invalidity, in whole or in part, of any of the provisions of these Terms and Conditions, shall not affect the enforceability of any of the other provisions thereof.

## 26. APPLICABILITY:

These Terms and Conditions as stated herein are applicable as of the date of this printing and until such time as changed by Seller.

Regal STCS-US Rev 5/14

# IMPORTANT INFORMATION - PLEASE READ CAREFULLY

The following **DANGER, WARNING** and **CAUTION** information is supplied to you for your protection and to provide you with many years of trouble free and safe operation of your Marathon® Special Products.

**⚠ DANGER** Devices sold by Regal provide for interconnection of electrical circuits and such are, or can be, points of live electrical contact. It is the responsibility of the Buyer or user to ensure through the use of enclosures, insulation, engineering controls, or other means in the application, that the wiring device is protected from intentional or accidental contact in an energized condition. Failure to do so can create the potential for electrical shock and associated serious injury.

**⚠ WARNING** Only qualified personnel should install and troubleshoot electrical products due to the potential for serious injury related to electrical shock. Make certain that the power supply is disconnected and/or locked out before attempting to install, remove or service components.

**⚠ CAUTION** Connection tightness is critical to electrical performance. Buyer, user, or installer must always ensure that the proper screw torque is applied and maintained.

Buyer or user must ensure that proper clearances are maintained between energized electrical components and all other devices including but not limited to the enclosure and mounting mechanism.

Install and ground per local and national code.

Buyer shall be solely responsible for determining the adequacy of the product for any and all uses to which Buyer shall apply the product. Buyer must ensure that the application of the device conforms to all standards, codes, policies or practices that govern or apply to their equipment or application. Regal uses design parameters, materials, and construction methods intended to meet the standards noted in the engineering catalog, with specific suitability of use and restrictions as noted in the appropriate agency files. The application by Buyer shall not be subject to any implied warranty of fitness for a particular purpose.

Products in this catalog are tested and listed with various standards agencies. They will meet or exceed all performance guidelines as tested and qualified. Buyer or user must check that applications do not exceed rated capacities of voltage and amperage and that appropriate wiring practices are followed.

Products are intended for use in an "as sold" condition. Modification of components can affect performance and ratings and subsequently the safety of the component system. Buyer or user assumes liability for component modification.

Electrical products in this catalog are designed for use in appropriate enclosures. Buyer or user is responsible to ensure that appropriate environmental control is designed into the application.

In the event of the resale of any goods, in whatever form, Resellers/Buyers will include the following language in a conspicuous place and in a conspicuous manner in a written agreement covering such sale:

The manufacturer makes no warranties or representations, express or implied, by operation of law or otherwise, as to the merchantability or fitness for a particular purpose of the goods sold hereunder. Buyer acknowledges that it alone has determined the goods purchased hereunder will suitably meet the requirements of their intended use. In no event will the manufacturer be liable for consequential, incidental or other damages. Even if the repair or replacement remedy shall be deemed to have failed of its essential purpose under section 2-719 of the Uniform Commercial Code, the manufacturer shall have no liability to Buyer for consequential damages.

Resellers/Buyers agree to also include this entire document including the dangers, warnings and cautions listed above in a conspicuous place and in a conspicuous manner in writing to instruct users on the safe usage of the product.

This information should be read together with all other printed information supplied by Regal.

# INDEX

Catalog #	PG #	Catalog #	PG #	Catalog #	PG #	Catalog #	PG #	Catalog #	PG #
3/4 ST	Web	133X559	18	140X801	11	145X301	13	17xx STD	30
1MS101	48	133X563	18	141X201	20	145X408	14	25TB Class	36
1MS102	48	133X564	18	141X202	20	145X411	14	26TB Class	36
1MS103	48	133X565	13	141X203	18	145X552	12	200 Series	31
1MS104	48	133X575	13	141X205	20	145X573	18	3TB Class	36
10TB Class	36	133X585	13	141X300	10	145X579	12	37TB Class	35
11TB Class	36	133X587	12	141X301	20	145X583	18	38TB Class	35
100 Series	31	133X588	12	141X400	10	145X586	13	39TB Class	35
1100 Series	28	133X595	12	141X403	10	145X592	13	300 Series	31
1102	28	133X596	13	142X121	10	145X594	12	4TB Class	36
1103P	Web	133X597	13	142X122	18	145X599	19	40TB Class	35
1104	28	133X598	13	142X123	20	145X606	19	41TB Class	31
1106	28	133X611	19	142X552	10	145X610	19	42TB Class	35
1107	28	133X953	12	142X553	20	145X613	19	400 Series	31
1108	28	133X955	12	142X570	10	145x615	19	410 Series	33
1112	28	1331348	13	142X572	10	145X986	14	410 GP Series	31
1200 Series	28	1343548	11	142X574	18	145X992	14	411 Series	33
1202	28	1343553	11	142X970	10	1453401	14	411 GP Series	35
1204	28	1343555	12	143X123	11	15TB Class	36	5TB Class	33
1206	28	1343570	10	143X126	11	1500 Series	30	599 Series	33
132X122	18	1343572	10	143X306	12	15xx DJ	30	599 GP Class	36
132X422	18	1343580	10	143X552	11	15xx DJSV	Web	6CC30AxB	44
132X474	18	1343582	11	143X553	11	15xx H	Web	6CC30AxBCU	44
132X570	10	1343585	13	143X554	11	15xx MCJ	Web	6CC30AxSPQ	44
132X572	10	1343588	12	143X555	12	15xx SC	30	6CC30AxSQ	44
132X574	18	1343595	13	143X559	18	15xx ST	Web	6F200AxBE	49
132X579	20	1343596	13	143X561	18	15xx STD	30	6F600AxB	49
132X580	10	1343597	13	143X563	18	15xx STRC	30	6G38 E C	40
132X670	20	135X601	13	143X587	12	15xx TP	30	6G38 E DIN	40
132X970	10	135X605	14	143X590	18	16TB Class	36	6G38 E F	40
132X972	10	135X701	13	143X953	12	1600 Series	30	6G38 TS C	39
133X126	11	135X702	14	143X955	12	16xx DJ	30	6G38 TS DIN	39
133X270	19	135X703	14	144X122	18	16xx DJSV	Web	6G38 TS F	39
133X272	19	135X704	14	144X401	11	16xx H	Web	6G38 TSKK	39
133X280	19	135X705	14	144X551	12	16xx MCJ	Web	6G38 TSKK C	39
133X305	11	135X706	14	144X553	18	16xx SC	30	6G38 TSKK DIN	39
133X320	13	135X707	14	144X557	12	16xx ST	Web	6G38 TSKK F	39
133X324	11	135X708	14	144X560	11	16xx STD	30	6G44 E DIN	Web
133X360	12	140X303	11	144X569	19	16xx STRC	30	6G44 SP DIN	Web
133X552	11	140X401	10	144X575	19	16xx TP	30	6H12 E C	41
133X554	11	140X402	10	144x614	19	17TB Class	36	6H12 E F	41
133X555	12	140x404	11	145X129	13	1700 Series	30	6H12 TSCU C	41
133x558	18	140x410	11	145X282	19	17xx SC	30	6H12 TSCU F	41



# INDEX

Catalog #	PG #	Catalog #	PG #	Catalog #	PG #	Catalog #	PG #	Catalog #	PG #
6J200AxBFBD	51	670A RZ Series	31	985 GP 10	29	CC1433	21	EPBAD21	7
6J400AxBFBD	51	671 GP Series	31	985 GP 11	29	CC1441	21	EPBAD24	7
6J600AxBFBD	Web	671 RZ Series	31	985 GP 12	29	CC1442	21	EPBAD42	7
6M30AxB	52	672 GP Series	31	0987 Series	29	CC1443	21	EPBAD45	7
6M30AxBCU	52	672 RZ Series	31	0987 RZ TC 02	29	CC1451	21	EPBAD48	7
6M30AxSPQ	52	699 Series	33	0987 RZ TC 03	29	CC1452	21	EPBAD71	8
6M30AxSQ	52	7TB Class	36	0987 RZ TC 04	29	CC1453	21	EPBAD74	8
6R30AxB	53	799 Series	33	0987 RZ TC 05	29	CC15xx	30	EPBAP42	7
6R30AxS	53	799 GP Series	33	0987 RZ TC 06	29	CC16xx	30	EPBAP45	8
6R30AxSP	53	8TB Class	36	0987 RZ TC 07	29	CC17xx	30	EPBAP48	8
6R60AxB	53	801 Series	31	0987 RZ TC 08	29	CC630	55	EPBAP71	8
6R100AxB	53	801 GP Series	31	0987 RZ TC 09	29	CC660	55	EPBAP74	8
6R200AxBE	53	802 Series	31	0987 RZ TC 10	29	CCM630	55	EPBAP81	8
6R400AxB	53	802 GP Series	31	0987 RZ TC 11	29	CH1321	21	EPBAP84	8
6SC30Ax-C	44	812 Series	33	0987 RZ TC 12	29	CH1322	21	EPBAP86	8
6SC30AxI-C	44	812 GP Series	33	Agency Apvs	1	CH1323	21	EPBCD42	7
6SJ30AxIC	50	885 RZ 01	29	BFPB Covers	Web	CH1331	21	EPBCD45	8
6SJ60AxIC	50	885 RZ 02	29	BFPB-37-1-3	6	CH1332	21	EPBCD71	8
6SM30Ax-C	52	885 RZ 03	29	BFPB-37-1-4	6	CH1333	21	EPBCD74	8
6SM30AxI-C	52	885 RZ 04	29	BFPB-37-1-5	6	CH1343	21	EPBCP42	7
6T100AxB	54	885 RZ 05	29	BFPB-37-1-6	6	CH1351	21	EPBCP45	8
6T200AxB	54	885 RZ 06	29	BFPB-50-2-2	6	CHR2100	55	EPBCP71	8
6T400AxB	54	885 RZ 07	29	BFPB-50-2-3	6	CHR230	55	EPBCP74	8
6T600AxB	54	885 RZ 08	29	BFPB-50-2-4	6	CHR260	55	EPBCP84	8
6TB Class	36	885 RZ 09	29	BFPB-50-2-5	6	CHR6100	55	F200AxBE	49
6W30A1C	Web	885 RZ 10	29	BFPB-50-2-6	6	CHR630	55	F600AxB	49
6W30A1F	Web	885 RZ 11	29	C72201	23	CHR660	55	FDS-30-C-1	45
600 Series	31	885 RZ 12	29	C72202	23	CJ6100-1C	55	FDS-30-C-2	45
600 GP Series	31	885 Series	29	C72203	23	CJ6100-2C	55	FDS-30-C-3	45
600A Series	31	899 Series	33	C72204	23	CJ6100-3C	55	Flexible Stranded Wire	3
600A GP Series	31	899 GP Series	33	C72205	23	CJ630	55	FSM25E	48
601 Series	31	9TB Class	36	C72206	23	CJ660	55	FSM37E	48
601 GP Series	31	912 Series	33	CC1402	21	Class H Fuse Panels	Web	FSM50E	48
602 Series	31	912 GP Series	33	CC1403	21	CVR-MCC	55	Fuse Holder Covers	55
602 GP Series	31	985 Series	29	CC1411	21	CW15xx	30	Fuse Holder Index	42
603 Series	31	985 GP 02	29	CC1412	21	CW16xx	30	Fuse Panels	Web
603 GP Series	31	985 GP 03	29	CC1413	21	DIN R 1	56	Fused Disconnect Switch	45
604 Series	31	985 GP 04	29	CC1414	21	DIN R 2	56	GL02	27
604 GP Series	31	985 GP 05	29	CC1421	21	DIN Rail Adapters	56	GL20	27
605 Series	31	985 GP 06	29	CC1422	21	Double Row TB Accessories	32	GL35	27
605 GP Series	31	985 GP 07	29	CC1423	21	EPB Series	7		
621 RZ Series	31	985 GP 08	29	CC1431	21				
670A GP Series	31	985 GP 09	29	CC1432	21				



# INDEX

Catalog #	PG #	Catalog #	PG #	Catalog #	PG #	Catalog #	PG #	Catalog #	PG #
Grounding Connector	27	MIK3	37	Power Block Covers	21	RG30AxB	46	ST722ExxxxT2	23
Grounding Lugs	27	MIK5	37	Power Block Index	5	RG30AxBCU	46	ST723 Series	24
HVPB Covers	21	MIK10	37	PV10BW	Web	RG30AxSPQ	46	ST723B3801	24
HVPB101	15	MIK16	37	PV10BWI	Web	RG30AxSQ	46	ST723B3802	24
HVPB103	16	MIK25	37	PV15BW32	Web	RJ, RJS Jumpers	32/34	ST750 Series	26
HVPB105	15	MIKE4	37	R6CC60AxB	44	RT30AxB	54	ST750M4	26
HVPB107	16	MIKE10	37	R6F30AxB	49	RT60AxB	54	ST750M6	26
HVPB108	15	MIKE16	37	R6F30AxS	49	SCCR	2	ST750M8	26
HVPB109	15	MIKSI5	37	R6F30AxSP	49	Semi Conductor Fuse Holder	48	ST750M12	26
HVPB112	16	MIKTS4	37	R6F60AxB	49	Single Row TB Accessories	34	ST750M16	26
HVPB114	16	Military Marking Strips	Web	R6F100AxB	49	Spacing Requirements	4	ST755 Series	26
HVPB201	16	MIW2	38	R6F400AxB	49	SPB (Straddle Plate)	32/34	ST755M4	26
HVPB203	16	MIW4	38	R6J30AxB	51	ST (Solder Lugs)	32/34	ST755M5	26
HVPB205	16	MIW16	38	R6J30AxS	51	ST710 31	25	ST755M10	26
HVPB207	16	MIW50	38	R6J30AxSP	51	ST710 31 Red	25	ST755M12	26
HVPB208	16	MIW70	38	R6J60AxB	51	ST710 38	25	STSF	Web
HVPB210	16	MKAW2	38	R6J100AxB	51	ST710 38 Red	25	Stud / Turret TBs	Web
HVPB211	16	MKAW10	38	R6T30AxB	54	ST710 Series	25	T100AxB	54
HVPB212	16	MKAW16	38	R6T30AxS	54	ST715 Series	24	T200AxB	54
HVPB214	16	MKAW25	38	R6T30AxSP	54	ST715S1902	24	T400AxB	54
HVPB602	16	MN35-2	40	R6T60AxB	54	ST722 Covers	23	T600AxB	54
Insulator Strips	Web	Modular FH	47	R30AxB	53	ST722 Series	23	Terminal Block Covers	32
J & JS Jumpers	32/34	Motor Terminal Blocks	26	R30AxS	53	ST722Bxx01	23	Terminal Block Index	22
J 12	41	MPC-3	40/41	R30AxSP	53	ST722Bxx02	23	Terms & Conditions	57-58
J 38	40	MPC-6	40/41	R60AxB	53	ST722Bxx03	23	Turret / Stud TBs	Web
KT's (Q-Connects)	32/34	MS 2	40/41	R100AxB	53	ST722Bxx04	23	Warnings	59
KT375	27	MSH Labels	38	R200AxBE	53	ST722Bxx05	23	WC12044	27
Marking Strips	32/34	MSK35	40	R400AxB	53	ST722Bxx06	23	WC12064	27
MC	40/41	MVB16-2	38	RF100AxB	49	ST722Bxxxx	23	Wire Clamp	Web
MFH Series	47	MVB16-12	38	RF30AxB	49	ST722BxxxxT1	23	Wire Connector Styles	43
MFH6063DD	47/51	MVB2-2	38	RF30AxS	49	ST722BxxxxT1S	23	Wire Reference Chart	2
MFH6063DD CH	47	MVB2-12	38	RF30AxSP	49	ST722BxxxxT2	23	Y, YSY, Z (solder lugs)	Web
MFH6153DD	47	MVB25	38	RF400AxB	49	ST722Exx01	23		
MFH6153DD CH	47	MVB4-2	38	RF60AxB	49	ST722Exx02	23		
MFH8065DD	54	MVB4-12	38	RF60AxSQ	49	ST722Exx03	23		
MFH8065FF	47	MVB6-2	38	RG15AxB	46	ST722Exx04	23		
MFH8065FF CH	47	MVB6-12	38	RG15AxBCU	46	ST722Exx05	23		
MFH8155FF	47	MVL2-2	38	RG15AxSPQ	46	ST722Exx06	23		
MFH8155FF CH	47	MVL4-2	38	RG15AxSQ	46	ST722ExxxxT1	23		
Midget FH	52	MVL6-2	38	RG20AxB	46	ST722ExxxxT1S	23		
MIK Hardware	38	MVL16-2	38	RG20AxSPQ	46				
		MVL25	38	RG20AxSQ	46				



**marathon**<sup>®</sup>  
Special Products

Regal Beloit America, Inc.

**APPLICATION CONSIDERATIONS**

The proper selection and application of power transmission products and components, including the related area of product safety, is the responsibility of the customer. Operating and performance requirements and potential associated issues will vary appreciably depending upon the use and application of such products and components. The scope of the technical and application information included in this publication is necessarily limited. Unusual operating environments and conditions, lubrication requirements, loading supports, and other factors can materially affect the application and operating results of the products and components and the customer should carefully review its requirements. Any technical advice or review furnished by Regal Beloit America, Inc. and/or its affiliates ("Regal") with respect to the use of products and components is given in good faith and without charge, and Regal assumes no obligation or liability for the advice given, or results obtained, all such advice and review being given and accepted at customer's risk.

For a copy of our Standard Terms and Conditions of Sale, please visit <http://www.regalbeloit.com> (please see link at bottom of page to "Standard Terms and Conditions of Sale"). These terms and conditions of sale, disclaimers and limitations of liability apply to any person who may buy, acquire or use a Regal product referred to herein, including any person who buys from a licensed distributor of these branded products.

Regal and Marathon are trademarks of Regal Beloit Corporation or one of its affiliated companies.

©2018 Regal Beloit Corporation, All Rights Reserved. MCC18004E • Form# 10203E

